

SCALE DISTORTION: FACT OR FALLACY?

The **Wireless World** MONTHLY ONE SHILLING

COVERING EVERY WIRELESS INTEREST

JANUARY 1942

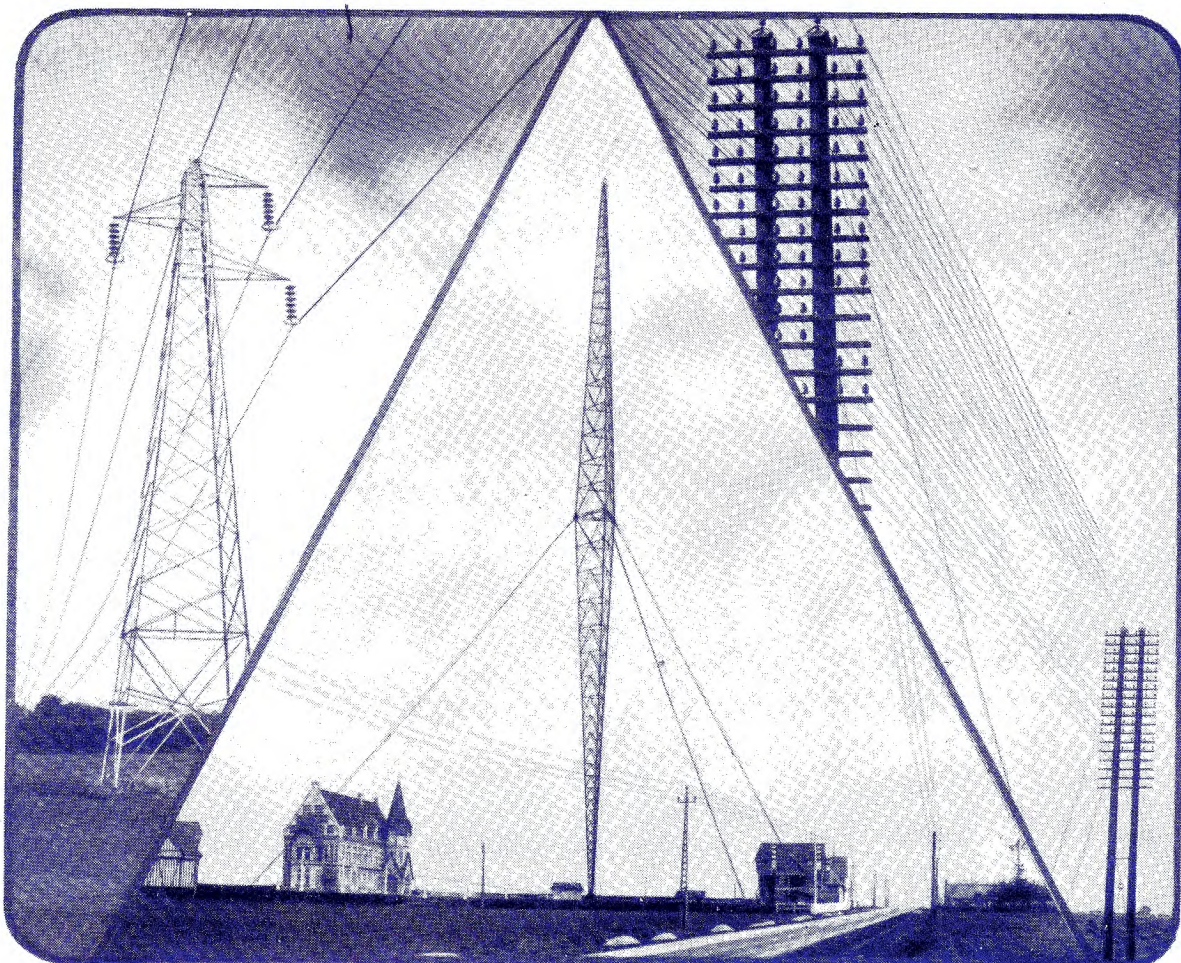

POST-WAR BROADCASTING: WIRE OR WIRELESS?

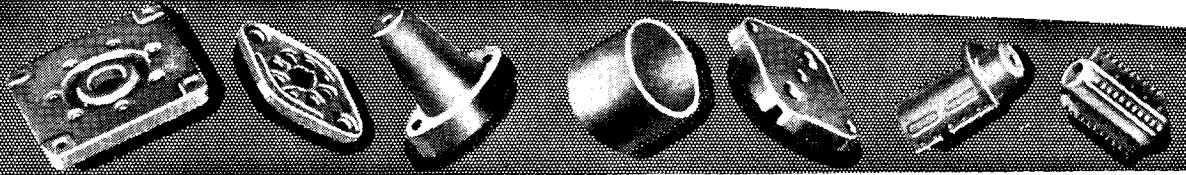

Going one better

IN COMMUNICATIONS



To-day, wherever Bullers Low Loss Ceramics are used, reception is clearer and better than ever before.

Years of research in Bullers Laboratories have developed these materials to such a high level of efficiency that Dielectric Loss is virtually eliminated. Bullers Ceramics are now playing a vital part in maintaining communications under all conditions.

**Made
in Three
Principal
Materials :**

FREQUELEX. An Insulating material of Low Dielectric Loss. For Coil Formers, Aerial Insulators, Valve Holders, etc.

PERMALEX. A High Permittivity Material. For the construction of Condensers of the smallest possible dimensions.

TEMPALEX. A material of medium permittivity of Condensers having a constant capacity at all temperatures.

BULLERS LIMITED
THE HALL, OATLANDS DRIVE, WEYBRIDGE, SURREY
Telephone : Walton-on-Thames 2451
Manchester Office : 196 Deansgate, Manchester.

Bullers

LOW LOSS CERAMICS



'AVO'

Regd. Trade Mark

Meters that Matter

BRITISH MADE

FROM years of intensive research in the design and manufacture of electrical testing equipment has grown the range of world-famous "AVO" Instruments. To-day, wherever rapid precision testing is demanded, there will be found the meters that matter—"AVO" Meters.

46-range Model 7
Universal AvoMeter

40-range Model 40
Universal AvoMeter

"Avo" Valve Tester with Universal Panel

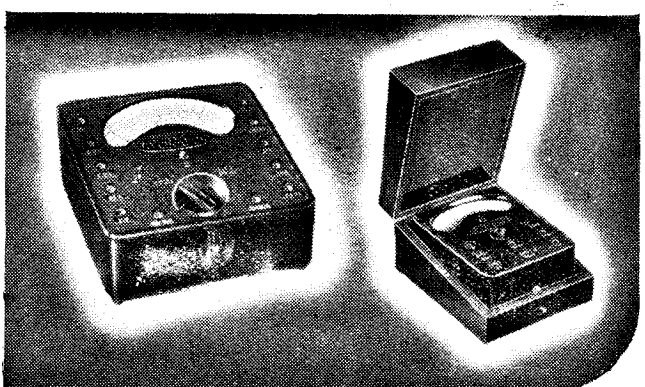
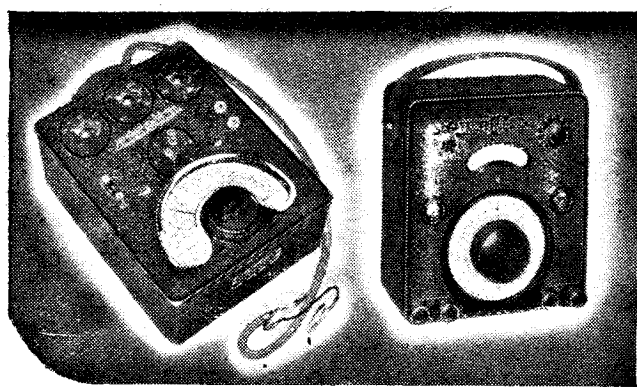
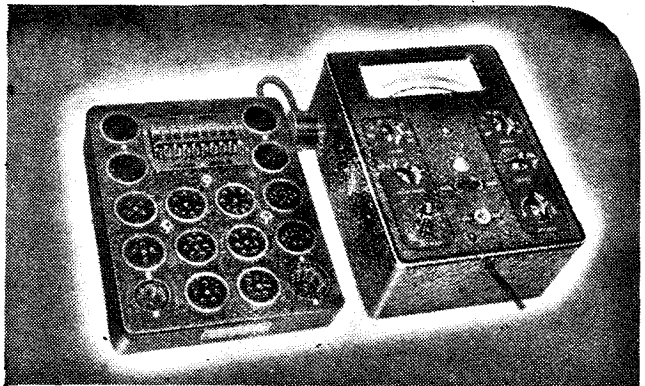
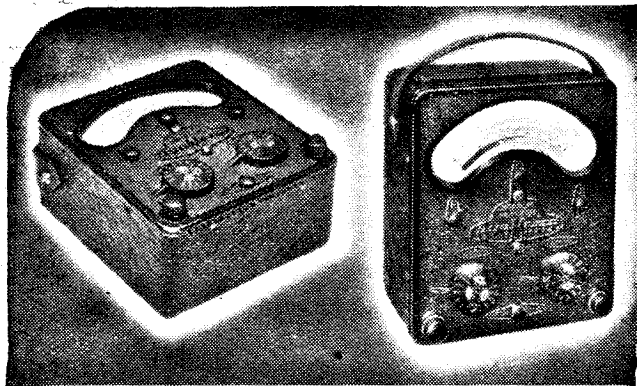

All-Wave "Avo" Oscillator

"Avo" Test Bridge

Universal AvoMinor

D.C. AvoMinor

OTHER "AVO" INSTRUMENTS
(Not Illustrated)

- "Avo" Bonding Meter.
- "Avo" Milliohmmeter.

Write for literature fully descriptive of any "Avo" Instrument in which you are interested.

Some delay in delivery of Trade orders is inevitable, but we shall continue to do our best to fulfil your requirements as promptly as possible.

Sole Proprietors and Manufacturers:

THE AUTOMATIC COIL WINDER & ELECTRICAL EQUIPMENT Co. Ltd.
Winder House, Douglas Street, London, S.W.1.

Phone: VICTORIA 3404-7.

Solder THE MODERN AND SPEEDY WAY

USE ERSIN MULTICORE

THE SOLDER WIRE
WITH 3 CORES OF
NON-CORROSIVE
ERSIN FLUX



- Avoids Dry Joints
- Increases Electrical Efficiency of Joints
- Speedily makes Sound Joints on Dirty or Oxidised Surfaces
- Always Correct Proportions of Flux and Solder
- No Additional Flux Required
- Low Melting Point (190° C. for 60/40 alloys)
- Approved by Air Ministry & G.P.O.
- All-British and acknowledged by the Leading Manufacturers to be the finest Cored Solder in the World.

FREE Two informative publications on soldering have been issued by Multicore Solders Ltd. Executives are invited to send for copies and a free sample of Multicore Solder.

MULTICORE SOLDERS LTD., BUSH HOUSE, LONDON, W.C.2

Telephone: TEMple Bar 5583/4



With all the Ocean for a Road

. . . . a ship ploughs its way to port. Often contact with the world seems all but lost through fog or gale. But thanks to radio, contact is *never* lost. Each ship, great or small, can receive whatever warnings, whatever orders, whatever news or encouragement its guardians afloat and ashore may send forth. Dubilier are proud to know that they are helping this great work, helping in the equipment which is bringing the ships home.

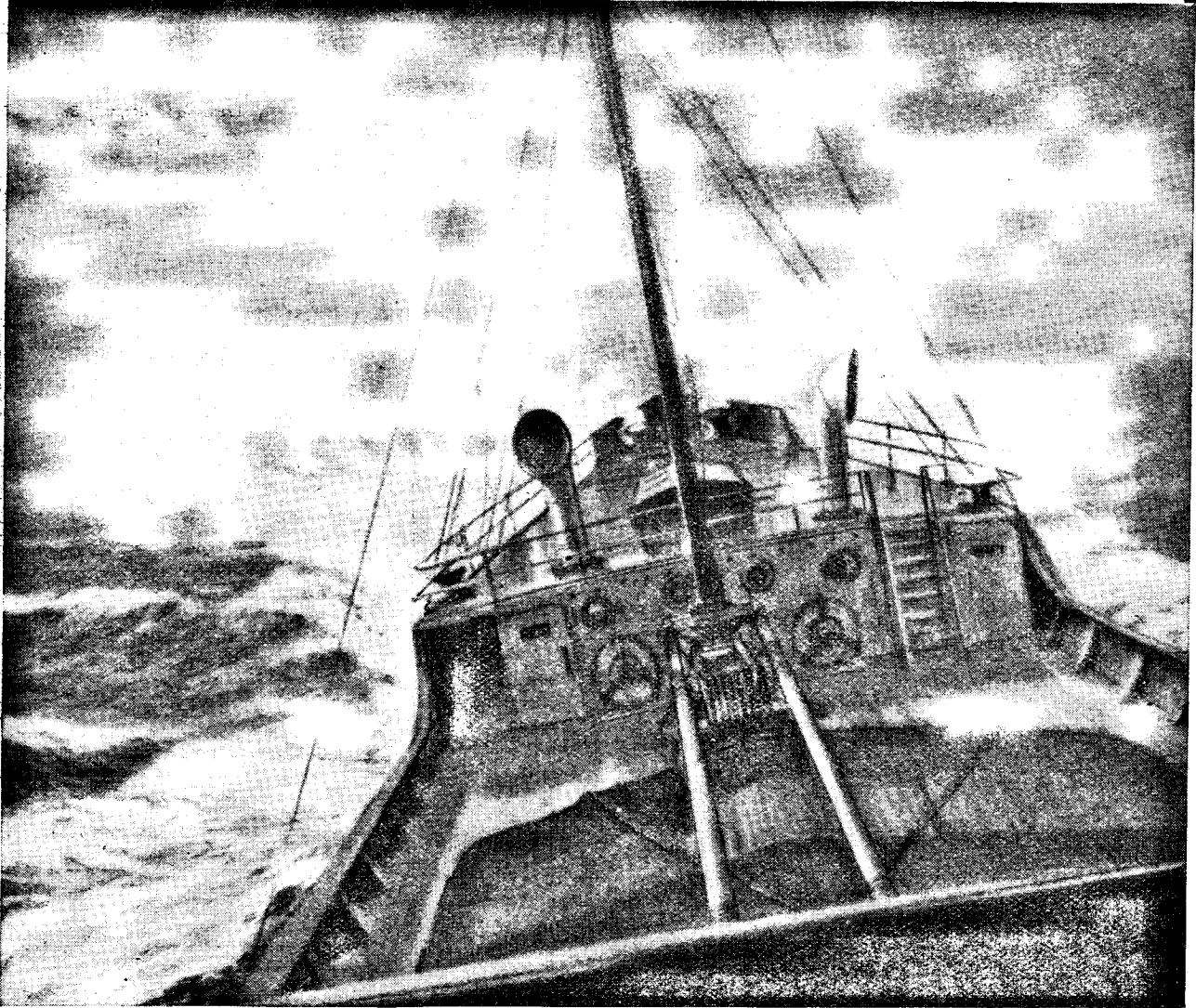

DUBILIER
CONDENSER CO. (1925) LTD.



H.T. from L.T. ACCUMULATORS

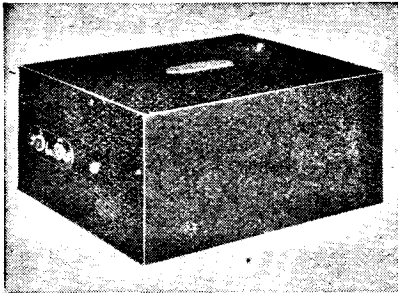

A **NEW** SELF-CONTAINED
RADIO POWER UNIT-THE NEW

Masteradio

VIBRATORPACK

MODEL 6AHTP for 6 Volts
MODEL 4AHTP for 4 Volts

1—Operates all types of Battery Sets from a "2 Valver" to a "Superhet" without the H.T. Battery replacement problem.

2—Designed for the most economical consumption. Constructed for Constant Output, Reliable Service and Maximum performance.

3—Completely enclosed in Metal Case—smaller than the H.T. Battery it Replaces— attractively finished in Brown Crystalline Enamel.

4—A product of the Leading British Manufacturers of Vibrator Operated Power Supply.



Full instructions for operation and maintenance provided with each unit.

Write for details

MASTERADIO LTD

Vibrant Works, 193, Rickmansworth Road, Watford, HERTS.

Telephone: Watford 9885/9890
Telegrams: Mastiola, Watford

PREMIER RADIO

DE LUXE S.W. KITS

Complete Kit, including all Valves, coils, wiring diagrams and lucid instructions for building and working. Each Kit supplied with a steel Chassis, Panel and plug-in coils to tune from 13 to 170 metres.

1-Valve Short-Wave Receiver or Adaptor Kit	24/6
2-Valve Short-Wave Receiver Kit	35/6
1-Valve Short-Wave Superhet Converter Kit	28/-
Utility Micro Dials, direct and 100-1	6/6

SHORT-WAVE CONDENSERS

Trolital insulation. Certified superior to ceramic. All-brass construction. Easily ganged.

15 m.mfd.	2/4	100 m.mfd.	3/-
25 m.mfd.	2/6	160 m.mfd.	3/7
40 m.mfd.	2/6	250 m.mfd.	4/-

ELECTROLYTIC CONDENSERS

16+24 525 v. Can. Neg., small type, 7/6; ditto, 32+32 mfd. 350 volt peak, 7/6; 25 mfd. 25 volt, 50 mfd. 12 volt, 1/6; 50 mfd. 50 volt, 2/6; 15 mfd. 100 volt, 1/3; 8 mfd. 125 volt tubular, 1/6.

Premier Pick-up with Arm and Volume Control, 17/6.

Rothermel Junior Model Crystal Pick-up, 31/10.

Rothermel Crystal Pick-up head, will fit any tone arm, 34/9.

Potentiometers, all res., 3/6; ditto, with Switch, 4/6.

PREMIER MICROPHONES

Transverse-Current Mike. High grade large output unit. Response 45-7,500 cycles. Low hiss level, 23/-.

Moving Coil Mike. Permanent magnet model requiring no energising. Response 90-5,200 cycles. Output .25 volt average. Excellent reproduction of speech and music, 49/-.

Crystal Mike, Rothermel D.105, 63/-.

Please Note.—All Short-wave Kits include Purchase Tax.

NEW PREMIER S.W. A.C. RECEIVER

In response to many requests we have now produced an A.C. version of the popular Premier Short Wave SG3 Kit. Circuit: Pentode H.F. Stage, Pentode Detector, Pentode Output, and F.W. Rectifier. 200-250 v. A.C. Operation. Built-in Power Pack. Hum-free operation. For use with Phones or P.M. Speaker.

Complete Kit of Parts with drilled chassis, all components, Plug-in Coils covering 13-170 metres, 4 valves and full instructions **£6.14.6** and circuits

Battery Version also available, Kit 24/15/4.

★ "The Wireless World" said they were "very much impressed..." ★

See full Test Report, pp. 492-3, December issue. Send for details.

LEARNING MORSE

Premier Morse Practise Key on Bakelite base and brass movement	3/3
General Purpose Morse Key	5/10
Bakelite Buzzers	2/6
3 Henry Chokes	7/6
Complete Valve Oscillator as described in "W.W." "Learning Morse"	27/6
Brown's Headphones	pair 17/6

ALL ENQUIRIES MUST BE ACCOMPANIED BY 2½d. STAMP.
ALL ORDERS LESS THAN 5/- 6d. POST EXTRA.

MOVING COIL SPEAKERS

P.M. Models. Goodmans 6½" 16/6, 8" 20/-.
Energised Models. Plessey 8", 2,000 ohm field, 15/-.
All speakers are complete with output transformer.

PREMIER RADIO CO.

ALL POST ORDERS to:

JUBILEE WORKS, 167, LOWER CLAPTON ROAD, LONDON, E.5. (Amherst 4723.)

CALLERS to:

Jubilee Works, or
169, Fleet St., E.C.4 (Central 2833), or
50, High St., Clapham, S.W.4. (Macaulay 7381.)

Greenwood

*Value proved
by long service*

Osram Valves

MADE IN
ENGLAND

for

BROADCAST RADIO

INDUSTRIAL APPLICATIONS

(INCLUDING P.A. SYSTEMS)

**ELECTRO MEDICAL
EQUIPMENT**

**THERMIONIC INSTRUMENTS
and TEST GEAR**

**VITAL COMMUNICATIONS
and WARNING SYSTEMS
ETC.**

THE GENERAL ELECTRIC CO. Ltd.
Magnet House, Kingsway, London, W.C.2

Links in the chain of Success

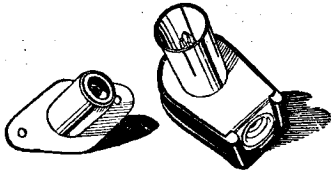

COAXIAL PLUG and SOCKET the first mass-produced type for coaxial leads. Supplied to grip air-spaced or solid di-electric cables. For mounting on chassis or cover of conduit box. All metal parts silver plated, moulded bakelite cover. Socket in each case is complete with plug.

Other Belling-Lee Activities:
Fuses 60 m/a. up to 300 amps.
Fuseholders, valveholders up to 12,000 volts. Terminals up to 100 amps. Plugs and sockets and couplings up to 10-way. Screened rooms and cabinets, anti-interference aerials, di-poles and speciality feeders.



BELLING & LEE LTD
CAMBRIDGE ARTERIAL ROAD, ENFIELD, MIDDX

2827

BATTERY CHARGERS

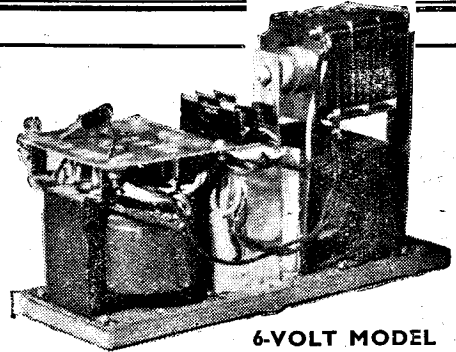

6-VOLT MODEL

A new delivery of these well-made Heavy Duty Battery Chargers is just to hand. Built of first class components with Metal Rectification and mounted on solid base board, as illustrated.
Input 200/245 volts A.C. Output 1½ amps at 6 v.

PRICE **35/-** EACH

CAR BATTERY CHARGERS - 6 v. @ 3 amps 50/-

● **SMALL TRICKLE CHARGERS** ●

These Chargers have metal rectification. Input 200-220v. A.C. Output 2v. ½ amp. Reliable and Shockproof. Price 17/6. Similar to above, but in metal case for mounting. Price 19/6.

COSSOR CATHODE RAY

COMPLETE TELEVISION EQUIPMENT
See our displayed advertisement in last month's issue for full details of this and other Cathode Ray Equipment.

• RADIO EQUIPMENT.

- MAINS TRANSFORMERS.** Originally made for Television Power Packs where accuracy and robustness are essential. Weight 12lb., size 5½in. x 4½in. overall. 350-0-350 v. 120 m.a. Tapped. 4 v. 2 a.; 4 v. 8 a.; 3 v. 3 a.; 20 v. 1 a. Diagram free. **25/-**
Post and packing 1/6
- HEAVY DUTY MAINS TRANSFORMER.** Input 240 v. A.C. One tapping at approx. 5,000 v. max. 20 m.a., and one for supplying filament of Mullard HVR 2 (6.3 v. at .65 amp.) Shrouded in metal box. Carr. fwd. **10/6**
Also input 200-250 v. A.C., approx. 6,500 volts. Shrouded in metal box. Carr. fwd. **20/-**
- ROLA ENERGISED SPEAKERS** 10in. 300 ohms. Pentode output transformer to suit 5/6 **12/6**
- GOODMAN'S** 8in. P.M. Speakers, brand new, boxed, complete with universal transformer. **18/6** Each
- B.I. CONDENSERS.** .1 x .1 mfd. 7,000 volt D.C. **20/-** test with porcelain insulators

MICROPHONES. Heavy duty, double button type. Chromium-plated case. Gold-plated electrodes. High output. Good Quality. With mounting clips and springs, complete with transformer **23/6**

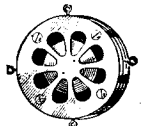

We regret that for the period of the war no orders can be sent C.O.D. Postage is extra on all items.

See also our Classified Advertisement on page 21.

LONDON CENTRAL RADIO STORES
23, LISLE STREET — LONDON, W.C.2

*Phone : GERrad 2969.

U.I.C

Ceramic Trimmer Condensers

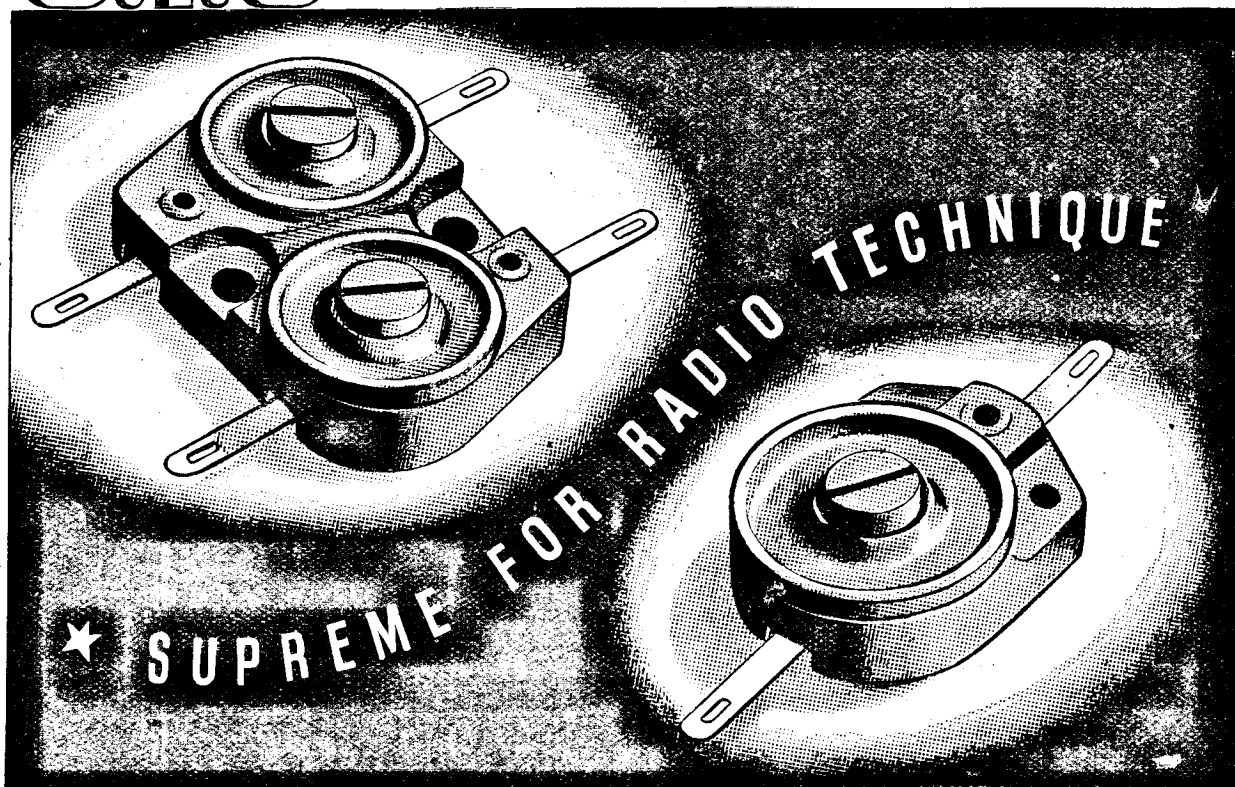

were the first in the field and are still unsurpassed.

Advantages include:

Simplicity of design and small size.

Low Loss factor (average 0.08% (Max. 0.2%) at 1000 kc/s).

Unaffected by temperature and humidity.

Minimum stray field.

Linear capacity law.

Full details and advice gladly given.

UNITED INSULATOR CO. LTD.

12-20, LAYSTALL STREET, LONDON, E.C.1

'Phone : TERminus 7383.

'Grams : CALANEL, SMITH, LONDON.

CONTRACTORS TO G.P.O. AND GOVERNMENT DEPARTMENTS.

ON A.I.D. APPROVED LIST.

Please note new address and telephone number.

The Pioneers of Low-loss Ceramics

★ RAYMART MICRO-VARIABLE CONDENSERS AND PRECISION DIALS AND KNOBS ★

Note these principal features of Raymart Micro-variable Condensers :-
All-brass construction. Heavy gauge vanes. Ball-bearing spindles. Electrical shorting device which short-circuits the ball-race. All parts turned from solid bars.

MIDGET (MCX) SERIES CONDENSERS

Type	Max. Cap. in mmfd.	Min. Cap.	Price
MC15X	13.5	3.0	1/10
MC60X	58	5.0	2/1
MC120X	124	8.0	2/5
MC5DX	5	3.0	1/10
MC15DX	15	5.0	2/-

Special condensers can be made with intermediate capacities. The ganging feature may also be omitted with a consequent saving in length. Quantity quotations on request.

Features of the range of Raymart Dials, include :-

Non-reflecting satin finish. Graduations deeply engraved, clear and easy to read. Accurate in workmanship and fine in appearance. Knobs to match these dials are available both with or without skirt.

TYPE TXO. 2 1/2 in. Dial, graduated 100-0, with no skirt on the knob of this dial (as illustrated) ... each 3/3
TYPE TXW. 2 1/2 in. special dial, without knob, but having solid metal boss and intended for use with our slow motion drive and dial locking device (as illustrated) ... each 3/-

TYPE SMD. A slow motion drive with dial cursor and locking device for use with the TXO, and any of the other dials excepting the TXS. This drive works on the edge of the dial by friction and there is a dial cursor and lock operating at the top of the dial. Price of complete assembly, with Type TXJ Knob is ... per set 3/6

3 in. Black Bakelite Skirt Knob, as used on TXD Dial ... each 1/9
 2 1/2 in. Black Bakelite Skirt Knob, as used on TXJ Dial ... each 1/3

Full details of Raymart precision Condensers and Dials will be sent on request. Enquiries invited from Government departments, Manufacturers, Servicemen, etc.

STANDARD (VCX) SERIES CONDENSERS

Type	Max. Cap. in mmfd.	Min. Cap.	Price
VC15X	15	2.5	1/9
VC40X	40	2.75	2/-
VC100X	100	3.8	2/3
VC160X	160	6.0	2/6
VC250X	250	7.3	3/-
VC20D	20	4.0	2/9
NC15	15	3.0	2/9
TC40	40	6.0	3/6

TYPE TXD. 4 in. Dial, graduated 0-100, as illustrated, complete with indicator each 5/9
TYPE TXJ. 2 1/2 in. Dial. Companion to TXD, with indicator, graduated 0-100 ... each 3/11

TYPE TXS. 2 1/2 in. Dial, satin nickel-finish, graduated 0-100, complete with Pointed Knob ... (Temporarily out of Stock)

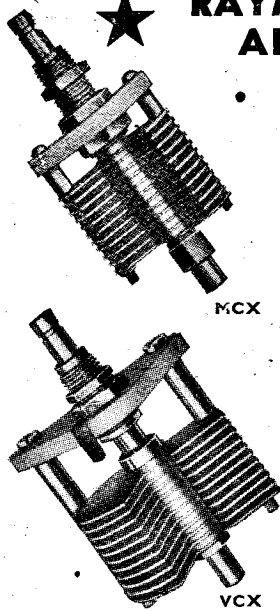

MCX

VCX

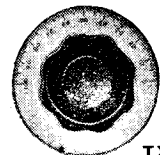

TXO

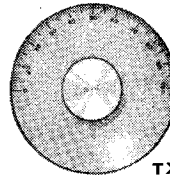

TXW

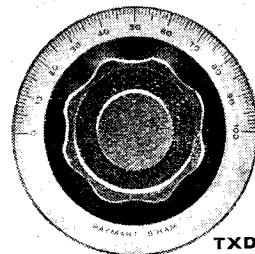

TXD

RAYMART

CRAFT A CREED

48, HOLLOWAY HEAD, BIRMINGHAM, I

Telephone : MIDLAND 3254

M.R. SUPPLIES

have the following first-class **ELECTRO-TECHNICAL EQUIPMENT** for sale from stock but have to advise immediate application. All goods brand new, perfect, and guaranteed.

ROTHERMEL-BRUSH PIEZO-CRYSTAL MICROPHONES. A new model of outstanding performance and appearance. In handsome satin black finished housing with chromium bezel and knuckle joint for angle adjustment, with 1" tapped boss for mounting. Response 50/8,000 c/s. Output level—60 db. Complete with screened lead, 72/6. This model has better performance and appearance than the well-known five guinea model and is undoubtedly to-day's best microphone opportunity.

G.E.C. MINIATURE MICROPHONES. Transverse current model of precise instrument construction, approx. 1 1/4" sq. Provided with clip for lapel use, 8 ft. lead and plug-connector. In spite of small dimensions these are suited for all serious uses. (List price 85/-.) We offer the last few at 33/6 each.

MICROPHONE/SPEAKER UNITS. High-efficiency model with performance equal to most expensive m/c mikes. Diameter 3 1/2", fitted weighty high-flux alnico magnet. Imped. 12 ohms. Ideal for intercom. systems and public address, 18/6. (Suitable transformer for use as either mike or speaker, 6/-.)

ROTHERMEL NEW JUNIOR PIEZO-CRYSTAL PICKUPS. Performance equal to the other well-known models (no longer available) but less expensive arm and swivel assembly. Fully recommended, 28/6 (inc. P.T.).

ERIGSON HEADPHONES. New, boxed, 4,000 ohms. Complete with adjustable headband, 20/- pair. No more than 6 pairs per order.

SMALL SYNCHRONOUS ELECTRIC MOTORS. For timing mechanisms such as clocks, time switches, recording apparatus, etc., and the most useful instrument for the laboratory. Totally enclosed with mounting brackets and lead. Diameter approx. 2" Self-starting. Voltage 200/250, 50 c. Geared to synchronous speeds of 1 rev. per minute or 1 rev. per hour (two models), 25/- each.

SLIDING REOSTATES, 100 watts capacity. Fully enclosed with bushed cable entry and laminated brush contact. Positive smooth action. Following range: 4 ohms 5 amps, 10 ohms 3 amps, 50 ohms 1.4 amps, 100 ohms 1 amp, 200 ohms 7 amp, 400 ohms 5 amp, any one 17/6.

BATTERY CHARGERS. 200/250 v. A.C., fitted metal rectifier. For charging 2, 6 and 12 v. batteries at 1.5 amp. Sturdily built in perforated metal cabinet arranged for table use or wall mounting. An excellent source of L.T./D.C. supply for many other purposes, 50/-.

L.T. METAL RECTIFIERS, D.C. delivery 12/14 v. 1.5 amp., 11/6.

SEMI-ROTARY SWITCHES, 6-circuit S.F.C.O., anti-capacity, with standard 1" spindle (slight rust on spindles), 1/- each, 10/6 dozen.

CADMIUM STEEL AMPLIFIER OR SET CHASSIS. Very heavy gauge, drilled for 5 valves and usual components, size 1 1/4" by 7 1/2". 2 for 6/6 or 4 for 11/6, post paid.

MORSE KEYS. American pattern, all-metal plated frame, adjustable for tension and arc spacing, 12/6. Also very superior "Bomber" model, 27/6. These keys are of the best "instrument" construction.

ELECTRO-MAGNETIC COUNTERS. 500 ohms coil. Counting up to 9,999. Operating from 20 v. D.C. to 250 v. A.C. Many industrial and other applications (S.H. ex G.P.O. —all perfect), 5/6.

BALANCED ARMATURE SPEAKER UNITS (Hegra). Now come in useful for other purposes than speaker—Morse instruction, vibrators for H.T. supply, etc. A few, brand new, at only 7/6 each.

MERCURY SWITCHES. 20 amp., on-off, 5/6. **PLESSEY 3-GANG CONDENSERS.** .0005, ball-bearing, with 50/1 S.M. drive, 8/6. **MULTI-RATIO OUTPUT TRANSFORMERS,** tapped prim. and sec., providing 8 ratios inc. push-pull, 6/-.

Please estimate postage. C.O.D. involves extra clerical work while we are short-staffed, so we prefer, but do not insist on, cash with order.

M.R. SUPPLIES, 68, New Oxford St., London, W.C.1

Telephone : MUScum 2958

TAYLOR ALL-WAVE SIGNAL GENERATORS

(6.5 to 3,000 metres)



Each of the 4 different models is a fully self-contained unit and provides modulated frequency signals for tests on all types of receivers.

Full details will be sent on request.

FOUR MODELS AVAILABLE

NOTE THESE IMPORTANT FEATURES

FREQUENCY RANGE. 6 overlapping ranges covering from 46 mc/s to 100 Kc.s. (6.5 to 3,000 metres.)

MODULATION. A separate valve, oscillating at 400 cycles, is employed to supply internal modulation, and can also supply up to 5 volts to the output jack on the generator. There is a choice of either internal modulation at 400 cycles, or, unmodulated or externally modulated by an external source of audio frequency.

ATTENUATION. Two attenuators provide for coarse and fine adjustments. 0 to 10 microvolts and multiplications of 10, 100, 1,000 and 10,000.

In view of general war conditions, deliveries are not as prompt as we all would like them to be, but, we continue to do our utmost to fill orders without undue delay.

BRITISH MADE and guaranteed 6 months.

TAYLOR ELECTRICAL INSTRUMENTS LTD.
148A, High Street, Slough, Bucks.
Telephone : Slough 21383.

£13-13-0

All models are supplied complete with instruction book, and all are priced at

Daddy - may I wear the MINK?

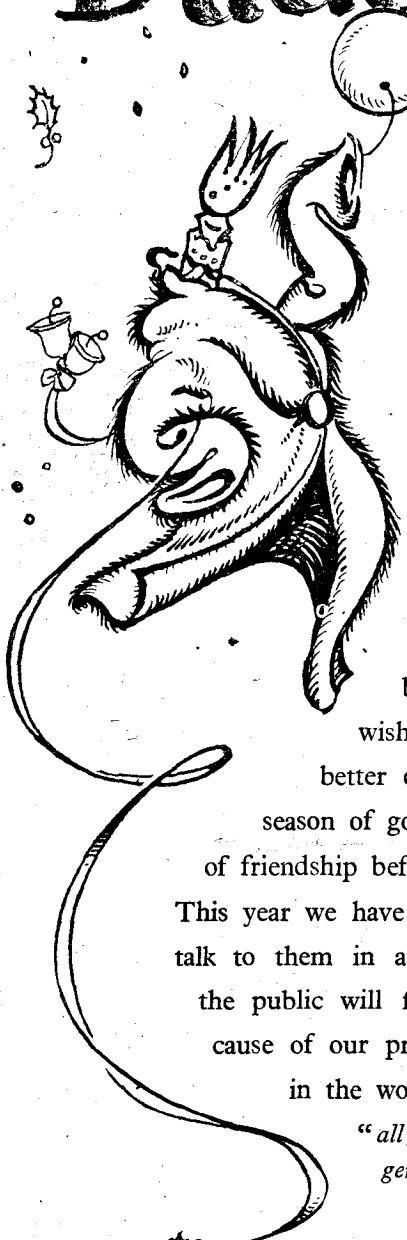

IT is given to us once a year in advertisement to shed the armour of our war effort and stand luxuriously clothed in the spirit of Christmas. Unashamedly we wish our friends—the readers of the “Wireless World”—a happy Christmas. Too many misanthropes bid us to be gloomy and sullen but, our life on it, we wish your Christmas to be merry and your New Year a better one than 1941. Let us not begrudge ourselves a brief season of goodwill and happiness—a moment to stretch the limbs of friendship before buckling on our overalls once again.

This year we have not been able to see so much of our friends or even talk to them in advertisements. Old friends in the trade and among the public will forgive us our long silence knowing, as they do, the cause of our pre-occupation. But we have had throughout the year, in the words of Mr. Weller,

“all good feelin’, sir — the verry best intentions, as the gen’l’m’n said ven he run away from his wife ‘cos she seemed unhappy with him.”

Therefore greetings and the best of luck.

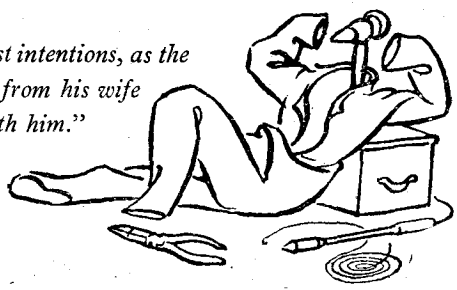

M U R P H Y

Murphy Radio Limited, Welwyn Garden City, Herts.

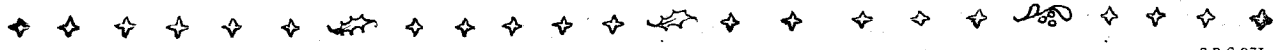

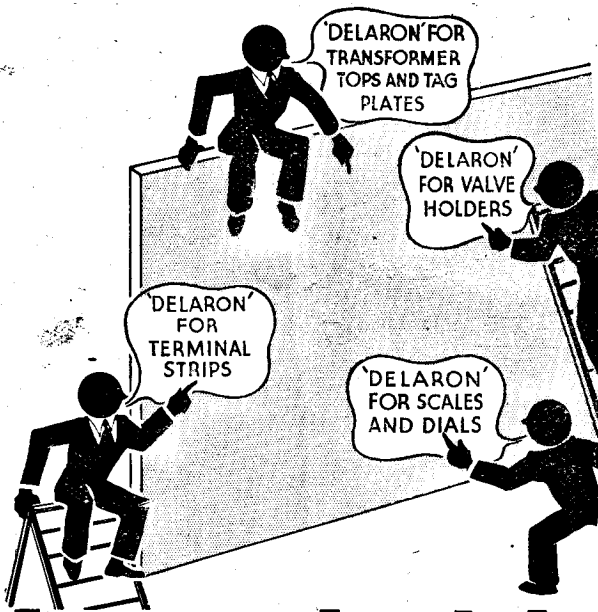

It's worth while looking well into DELARON

LAMINATED MATERIAL

And these are just a few of the multitudinous uses to which can be put the many grades of 'DELARON' — a high quality Laminated Material in Fabric and Hard Paper Sheets which can also be made available in panels and strips cut to your special needs. If you now use, or are contemplating using, this type of material, then examine the qualities and possibilities of 'DELARON'—we believe it will pay you in the long run. Supplied in Air Ministry and Ministry of Supply approved grades, 'DELARON' is proving its worth daily in the field of Radio Engineering. Fullest details, samples and the services of our sales engineers are freely at your disposal.



5, REGENT PARADE, BRIGHTON ROAD,
SUTTON, SURREY
Tel.: Vigilant 4472

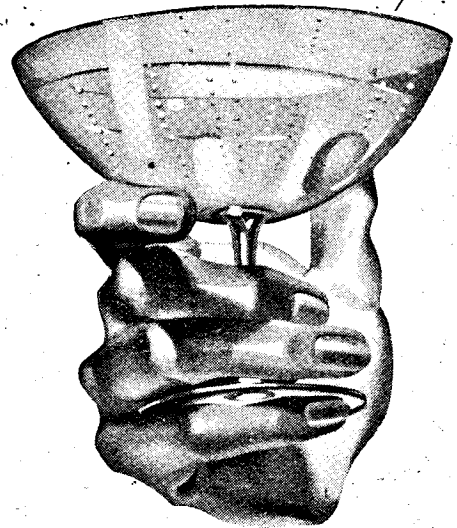

MARCONI-MEN

*— our greetings
and a toast!*

“to the future and the
good things to come”

MARCONIPHONE

the REAL thing

THE MARCONIPHONE COMPANY LIMITED, HAYES, MIDDLESEX

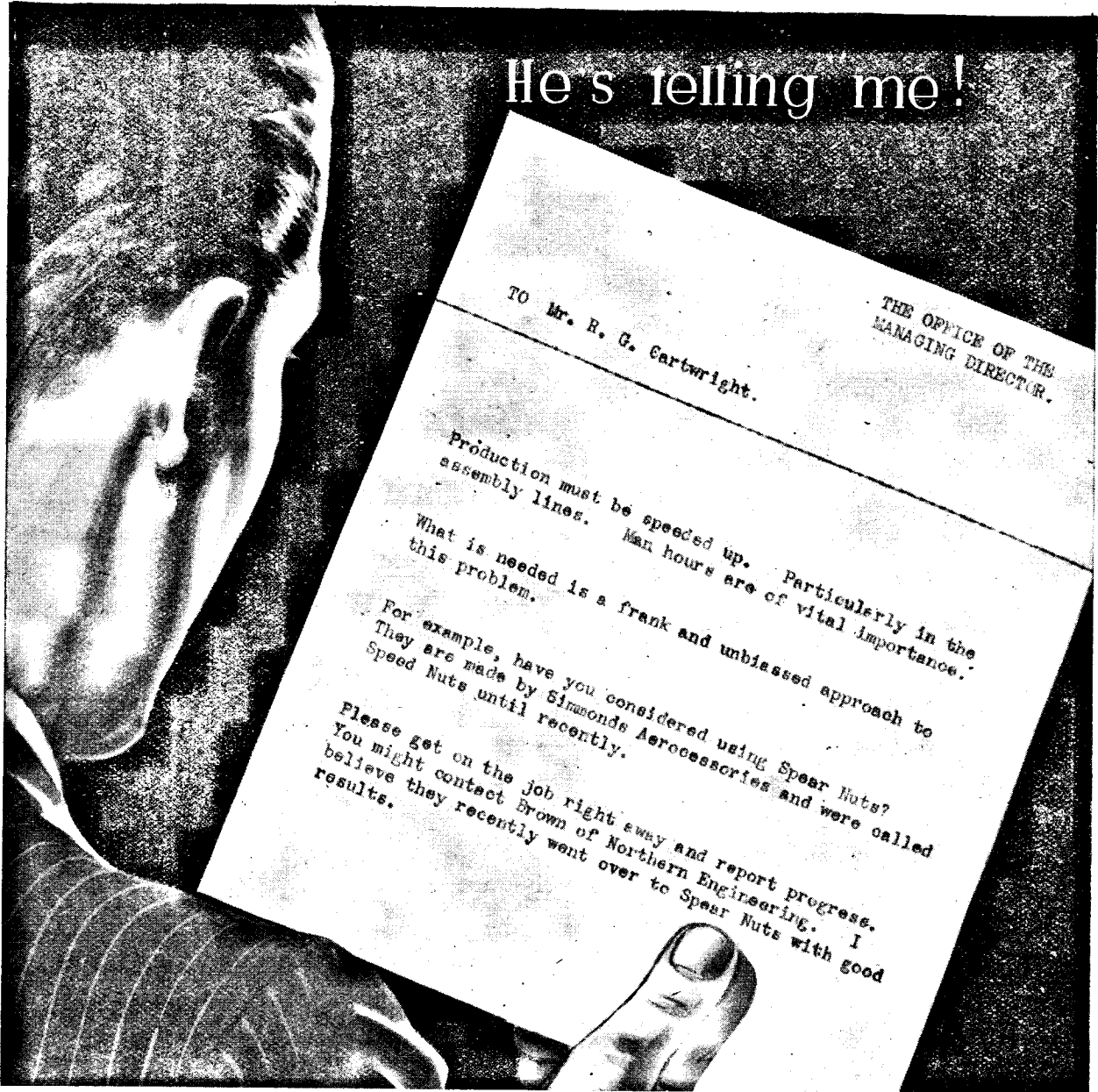

He's telling me!

TO Mr. R. G. Cartwright.

THE OFFICE OF THE
MANAGING DIRECTOR.

Production must be speeded up. Particularly in the assembly lines. Man hours are of vital importance.

What is needed is a frank and unbiased approach to this problem.

For example, have you considered using Spear Nuts? They are made by Simmonds Aeroaccessories and were called Speed Nuts until recently.

Please get on the job right away and report progress. You might contact Brown of Northern Engineering. I believe they recently went over to Spear Nuts with good results.

There is no limit to the application of the Spear Nut system. Investigate this time and labour saving method NOW. Our Development Department is entirely at your service and will be pleased to collaborate.

Spear TENSION LOCK Nuts

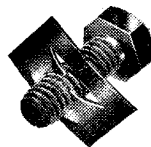

SIMMONDS AEROCESSORIES LTD
GREAT WEST ROAD, LONDON



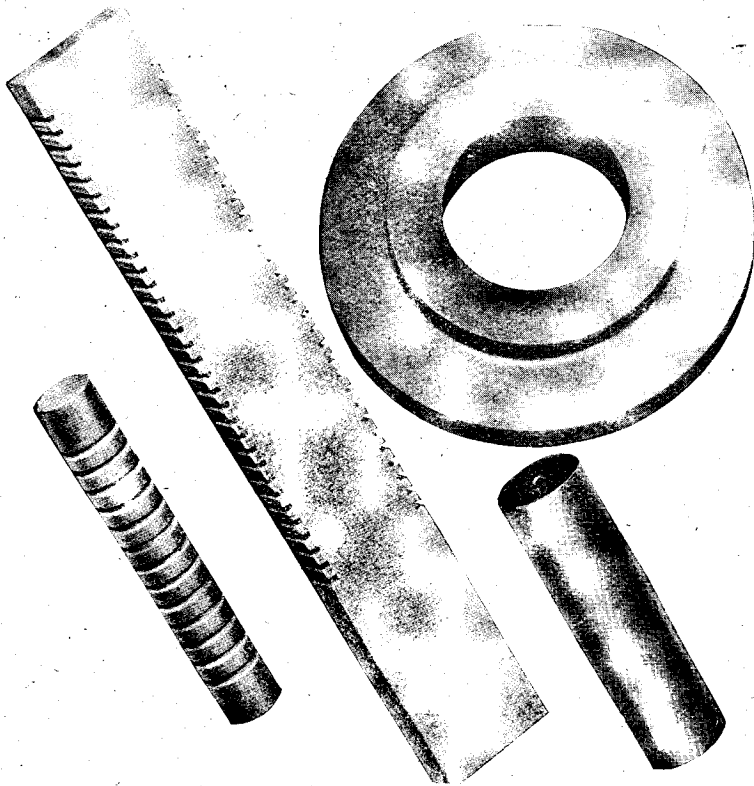

MYCALEX

(REGD. TRADE MARK)

for arc resistant uses demanding more than the average safety margin

Readily machinable to fine limits and of toughness allowing safe use of lighter sections than other insulating materials, MYCALEX is ideal for radio transmission or reception insulation, short and ultra-short wave (television) insulation, in fact, all high frequency work.

The special qualities of MYCALEX make it possible to produce complete components of this material. Many clients have solved production problems and reduced costs by consulting us. Our experience is at your service on application to
MYCALEX LTD., CIRENCESTER.



TENAPLAS PRODUCTS

made with
TENAPLAS

K and L EXTRUDED PLASTICS

TENAPLAS LTD. Head Office : 7, PARK LANE, LONDON, W.1

B.I. COPPER EARTHING RODS

for
WIRELESS APPARATUS

(U.K. Patent Nos. 438598, 423386, 430040).



U.K. Regd. Trade Mark.

100% MORE SURFACE AREA

Designed to give a low resistance earth contact. Made from solid drawn H.C. copper. The multiple fins ensure larger surface area and better contact with the earth than any driving earth of similar diameter and weight at present on the market; giving nearly 50 per cent. more contact area than a circular rod of equal diameter, or 100 per cent. more than a solid rod of equal weight.

About 1 1/2" of the rod is left exposed and the earth lead is simply clamped against the rod by means of the copper clamp ring and screw. No sweating or soldering is required. Supplied in two standard sizes, 18" and 24". Longer rods of similar type can be supplied, if desired, to meet special requirements.

BRITISH INSULATED CABLES LTD.,
CABLE MAKERS AND ELECTRICAL ENGINEERS,
Head Office : PRESCOT, LANCs.
Telephone No. : PRESCOT 6571.

A new high level in
 Communication
 Receiver performance

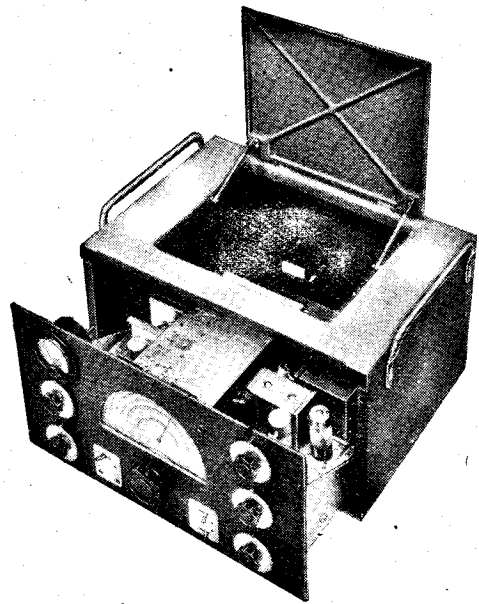

EDDYSTONE '358' and '400'

The Eddystone '358' and the medium frequency Model '400' are applications of the latest research and design to the production of communication receivers that in every way meet the exacting demands of present day operation. An unusual degree of sensitivity and selectivity and a high signal to noise ratio are combined with reliability and robustness. Both models are also available with Bandpass Crystal filters. Details and prices will be sent on request, but both sets are supplied to priority order only.

EDDYSTONE '358' COMMUNICATION RECEIVER

SPECIFICATION. The receiver employs one stage of R.F. amplification, frequency changer, two I.F. amplifiers, a separate beat frequency oscillator, octal base Mullard or Osram 6.3 volt valves. Frequency range is continuous from 22 m/cs. to 1.25 m/cs. using four fully screened interchangeable coil units. **Five additional coil units extend the range to 31 m/cs. and 90 k/cs.** Illuminated dial is accurately calibrated with four standard coils. Additional coils supplied with separate graph. **TO SIMPLIFY MAINTENANCE** a metre and test switch is fitted. Main tuning control incorporates fly wheel drive and spring loaded Tufnol gearing (ratio 70-1). Logging scale supersedes the old type band spread control. **SEPARATE POWER UNIT** assures freedom from drift and overheating of the R.F. and I.F. stages.

MEDIUM FREQUENCY MODEL '400':- A highly sensitive receiver covering medium frequencies only. Similar to the '358,' but is provided with four coils only covering frequency range from 130 k/cs. to 2,200 k/cs. Optimum gain is secured with very high signal to noise ratio.

ENERGETIC PRODUCTION has now made available a range of Eddystone components that meets most requirements. Additions to the range will rapidly be forthcoming.

WEBB'S RADIO

THESE RECEIVERS
 ARE SUPPLIED ON
 PRIORITY ORDER
 ONLY

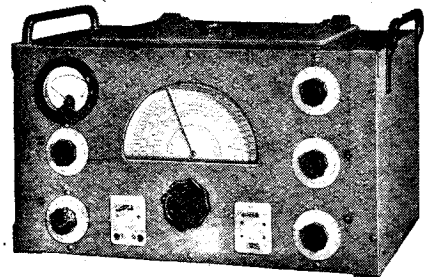

WEBB'S RADIO, 14, SOHO ST., OXFORD ST., LONDON, W.1. Tel.: GERrard 2089. Open 9 a.m.—4 p.m. Sats. 12 noon

In the considered judgment of leading engineers...

When important decisions are made about radio valves it is not uncommon for an Eimac valve to win the honors. *Reason:* the designers of Eimac valves have consistently held as their objective the anticipation of the future requirements of the radio industry. Efforts have not been confined to the production of a valve for yesterday's requirements.

This policy has kept Eimac valves ahead of the industry...a factor that is logical because the efficiency and progress of radio depends almost entirely upon the development of new ideas...new improvements in radio valve performance. Take the Eimac 250T, for example, which now possesses the most recently developed refinements. Check these features illustrated below and then check the performance of Eimac valves in your transmitter. You'll see then why Eimac valves are to be found in most of the important new developments in radio.

Follow the leaders to

Eimac
TUBES

Eitel-McCullough, Inc.
San Bruno, California, U. S. A.

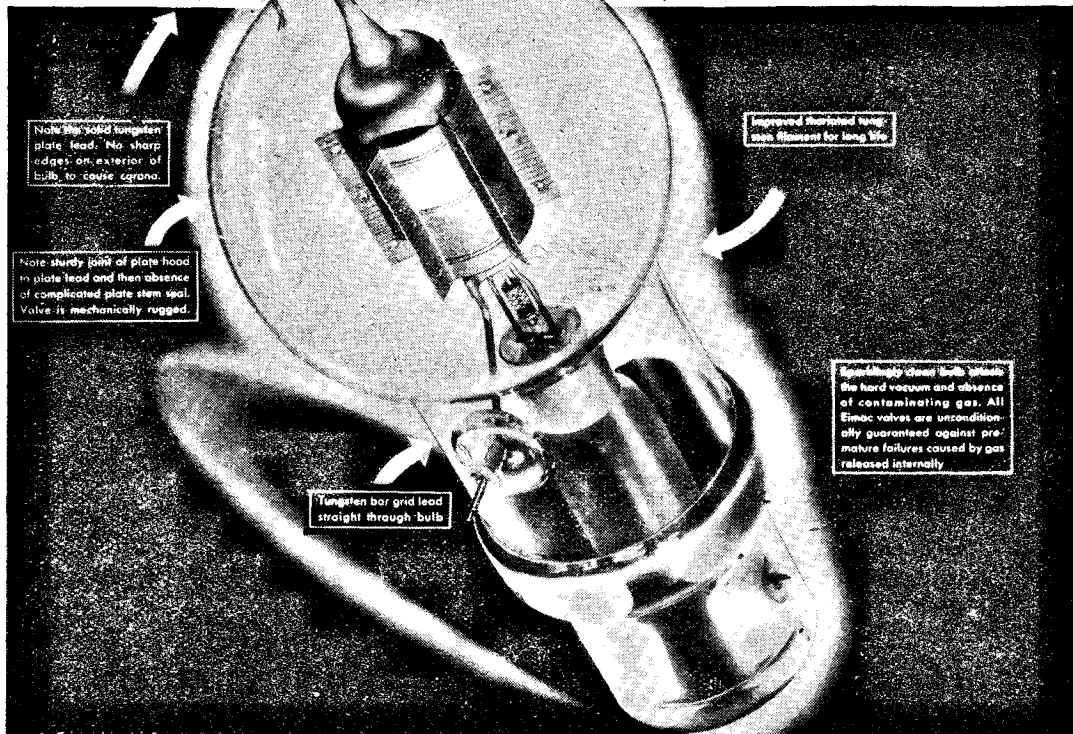

Export Agent: FRAZAR & CO. LTD., 301 Clay Street, San Francisco, California, U. S. A.

The Wireless World

32nd
Year of Publication
Covering Every Wireless Interest

JANUARY 1942

Proprietors :
ILIFFE & SONS LTD.

Editor :
HUGH S. POCKOCK.

Editorial, Advertising
and Publishing Offices :

DORSET HOUSE,
STAMFORD STREET,
LONDON, S.E. 1.

Telephone:
Waterloo 3333 (35 lines)

Telegrams:
"Ethaworld, Sedist, London."



**PUBLISHED
MONTHLY**

Price: One Shilling

(Publication date 20th
of preceding month)

Subscription Rates
Home and Abroad
14/- per annum

EDITORIAL	1
MAINTAINING S-W COMMUNICATION. By T. W. Bennington	2
SCALE DISTORTION. By A. S. Evans	5
THE ECKERSLEY PLAN. By P. P. Eckersley, M.I.E.E.	7
PORTABLE HT BATTERIES	9
AMATEUR TWO-WAY TELEVISION	10
THE WORLD OF WIRELESS	13
NEWS IN ENGLISH FROM ABROAD	15
LETTERS TO THE EDITOR	16
DC VALVE VOLTMETER	17
UNBIASED. By Free Grid	20
AN "ALL-DRY" PORTABLE. By S. W. Amos, B.Sc.(Hons.)	21
RANDOM RADIATIONS. By "Diallist",	22
RECENT INVENTIONS	24

Branch Offices :

COVENTRY :
8-10, Corporation Street.
Telephone: Coventry 5210.
Telegrams: "Autocar, Coventry."

BIRMINGHAM :
Guildhall Buildings,
Navigation Street, 2.
Telephone:
Midland 2971 (5 lines).
Telegrams:
"Autopress, Birmingham."

MANCHESTER :
260, Deansgate, 3.
Telephone:
Blackfriars 4412 (4 lines).
Telegrams:
"Iliffe, Manchester."

GLASGOW :
26B, Renfield Street, C.2.
Telephone: Central 4857.
Telegrams: "Iliffe, Glasgow."



As many of the circuits and apparatus described in these pages are covered by patents, readers are advised before making use of them, to satisfy themselves that they would not be infringing patents.



Greetings to all our Friends

Wherever you may be, whatever duty you may be performing in to-day's fight for liberty and decency, we send to you sincere

Hearty Greetings and Good Wishes

May the Best of Luck attend you in the months to come.

THE DIRECTORS AND STAFF

McMichael Radio Ltd.

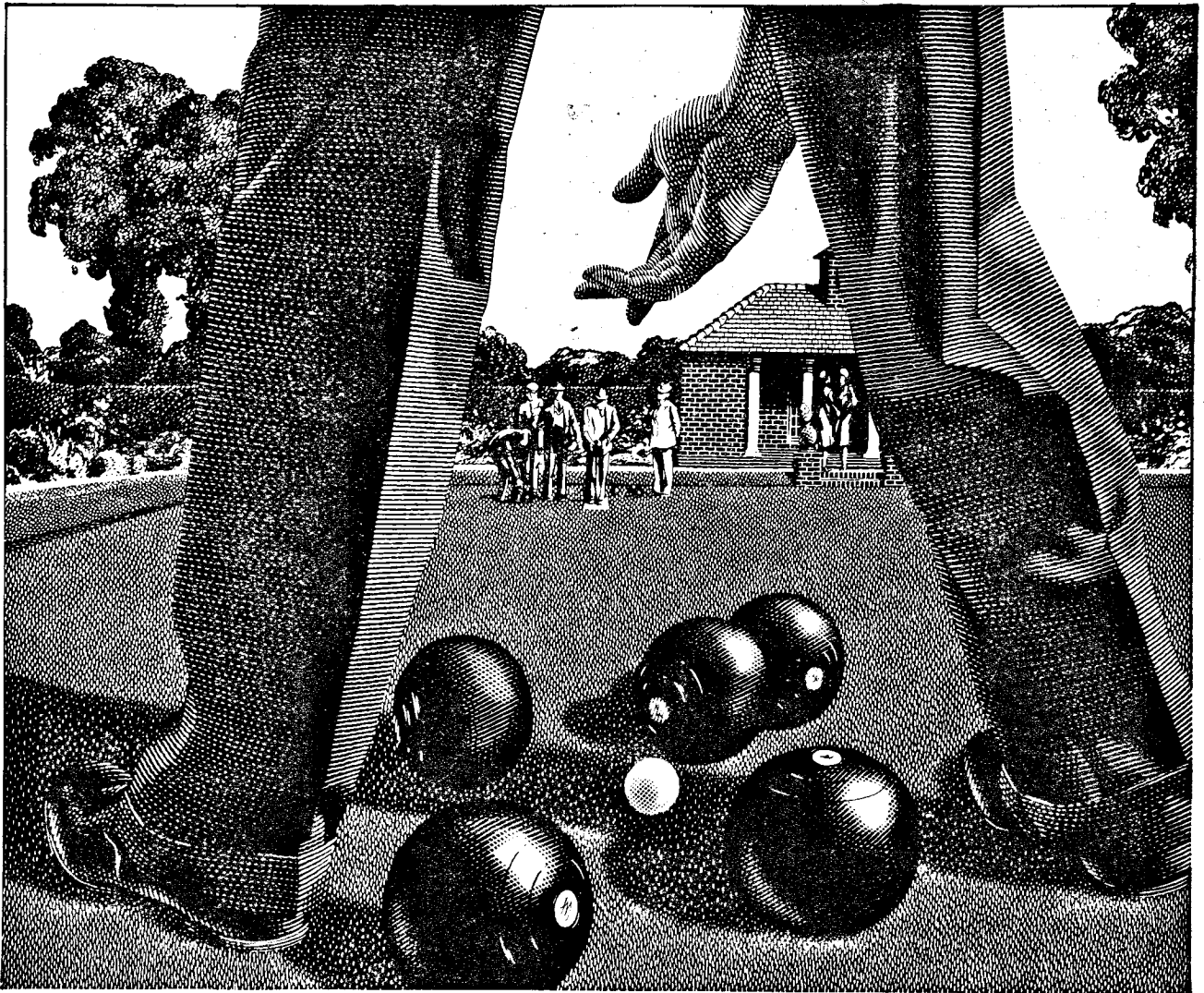

The Set Objective

A hand beckons . . . the 'wood' describes a graceful arc and comes slowly to rest. With Mullard, too, the beckoning hand of world events shapes a course for progress to follow. And Mullard technical skill is

guided and directed towards that end. The new developments in electronic technique taking place in Mullard laboratories and factories today will determine the trend of manufacturing policy for years to come.

MULLARD

THE MASTER VALVE

TRANSMITTING AND RECEIVING VALVES FOR COMMUNICATIONS · BROADCASTING
TELEVISION · SOUND AMPLIFICATION · ELECTRO-MEDICAL EQUIPMENT · INDUSTRIAL EQUIPMENT

THE MULLARD WIRELESS SERVICE CO. LTD., CENTURY HOUSE, SHAFTESBURY AVENUE, LONDON, W.C.2

The Wireless World

COVERING EVERY
WIRELESS INTEREST

ESTABLISHED
1911

Vol. XLVIII. No. 1075

JANUARY, 1942

Price One Shilling

Wire or Wireless?

Post-war Distribution of Broadcasting

THERE has of late been some fluttering in the wireless dove-cotes over the interest manifested in various quarters—including some rather unexpected ones—in the question of distributing broadcasting by “wired wireless” or carrier methods instead of through purely radio channels as at present. We of *Wireless World* would share the disquiet that seems to be felt if we thought that there was any possibility of this country being stampeded, immediately after the war, into accepting the wire as the main source of programmes.

In this matter we are not swayed by mere conservatism, or by any feeling that our technique will be overshadowed by the proposed system. Indeed, wired wireless employs what are, with one obvious exception, inherently radio principles, and has always been regarded as within our purview. It has long been realised that in the world of communications wire and wireless have their separate spheres. To use wireless where the wire will serve is inefficient and wasteful. But, if for the sake of argument we admit that technically the carrier system has all the virtues and none of the vices we would still be strongly opposed to its general adoption. The world is not ready for it yet; radio broadcasting is a safeguard of democracy, and will be needed more than ever during the critical post-war period of readjustment.

Imagine what would have happened in the enslaved countries of Europe if they had all had wire broadcasting instead of radio. Except for a few enthusiasts in possession of radio receivers, the people would have been able to hear nothing but Nazi propaganda. Few would have heard those messages of hope and encouragement from the freer outside world telling them that it is still worth while resisting.

Imagine, again, what might happen in our own country during the post-war reconstructional period when, properly applied, international radio broadcasting might well play a worthy part in founding a permanent peace. So, admittedly, might wire broadcasting in conjunction with international links, but, as compared with radio, it surely lacks something as a medium for the free interchange of thought between peoples. For example, the ties that bind us to our American allies could be strengthened by free interchange of programmes, received on this side on the better “all-wave” sets that it is hoped will be available. Re-broadcasting of picked programmes alone would not achieve so much.

Control of either wire or wireless systems could presumably be gained with almost equal readiness, either constitutionally or otherwise, by a dictatorial or usurping power, but—this is the important point—complete control over the dissemination of information could not be so effectively maintained through a radio system, most of the listeners to which would possess the apparatus for hearing views from overseas. Hitler realised that when he introduced the short-range Volksempfänger, which gave him some of the advantages of a wire system in canalising public opinion to his own ends.

Another argument in favour of radio is that broadcasting has for many years been commercially the most important side of wireless, and, directly or indirectly, has provided large sums of money for research. This has benefited all branches of the art, and important contributions to our war effort have been made as a result. Though, as we have shown, wired wireless broadcasting is by no means devoid of technical interest, it would provide less incentive to research, and stagnation might well result in many spheres.

Maintaining S-W Communication

Range of Frequencies Necessary Throughout a Complete Sunspot Cycle

Data on ionosphere conditions is steadily accumulating, and it is now possible to choose in advance with some assurance the best wavelength for any long-distance route at any time. It is evident that a fairly wide choice of frequencies is necessary to cover all conditions, and that the allocations at present in force for the various services are not always entirely adequate. For instance, amateur transmitters would benefit by an extra frequency for use in a sunspot minimum summer

By T. W. BENNINGTON

this way use is made mainly of the upper layer as a refracting medium. This is called the F layer when, as during the night, it exists as a single layer, but during the day it splits into two layers, the upper of which is the F₂ and the lower F₁. The higher the ionisation in this layer and the more obliquely the wave strikes it, the higher is the frequency which it can return. The highest frequency which can be returned from it so as to come down at a given distance is the "maximum usable frequency" for that distance. Because of the curvature of the earth—and of the ionosphere—the greatest distance that can be covered in one "hop", is about 3,500 km. (it varies somewhat according to the time of day and season of year). During the summer day, the lower layers (F₁ and E) become sufficiently ionised to "overshadow" the F₂, and when this occurs communication can only take place by way of the F₁ or E as the case may be. The F₂ cannot then be used, because any frequency which is high enough to penetrate the lower layers will also penetrate the F₂. However, the F₁ and E layers also show an increase in their ionisation towards the maximum of the sunspot cycle.

In going up to the F layer the wave must pass through the lower layers, and in them occurs the main absorption of energy. The principal source of absorption is the E layer. The

THE frequencies of use for long-distance short-wave communication are dependent upon the conditions existing in the particular ionosphere layer which acts as a refracting medium for the waves, and in that which absorbs energy from them. The degree of refraction and the amount of absorption to which a wave of given frequency is subject depend upon the ionisation existing in the different layers, and this—since it is produced by the action of the sun upon the high atmosphere—varies according to time of day, season of year and epoch of the sunspot cycle.

Measures of the critical frequencies and virtual heights of the principal layers are now available for a period corresponding to considerably more than half a sunspot cycle, so that it is possible to see what amount of variation will occur in the working frequencies suitable for any transmission path over a whole cycle. In making this statement it is assumed that conditions at the next sunspot minimum will be similar to those which prevailed in 1933—the year of the last minimum.

The progress of the sunspot cycle from 1933 to 1940 is shown in Fig. 1, which is a graph of the yearly means of the sunspot "relative numbers." These "sunspot numbers" represent one method of recording sunspot activity, being indicative of the total area occupied by the visible spots. The yearly means are given because values for shorter periods show large fluctuations which do not seem to be of any importance so far as ionosphere conditions are concerned. It is seen that solar activity—as evidenced by the sunspots—rose from its minimum

in 1933 to a maximum in 1937, and that by the end of 1940 it was well on its way towards a minimum again. It is expected that the next minimum will occur about 1944.

The effect of the rise and fall in solar activity may be seen in Fig. 2. This is a graph of the monthly average of the critical frequency of the principal refracting layer—i.e., the highest frequency which is returned by the layer when the wave is sent vertically upwards—at Washington for noon and midnight. The large peaks and troughs in the graphs are due to the seasonal changes, but it is seen that there is a general rise in the critical frequency towards the sunspot maximum, both for day and for night. This is due, of course, to the greater ionisation existing in the layers at the maximum, and it indicates that higher frequencies should be used for short-wave communication at that time than at the minimum.

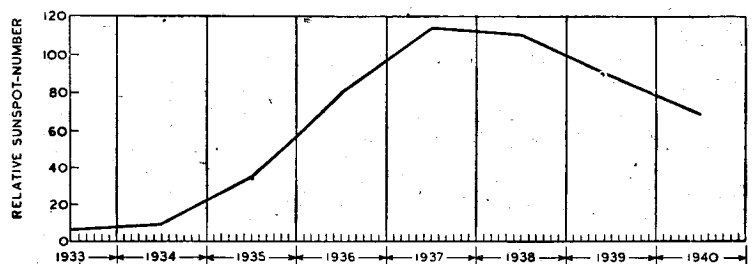

Fig. 1. Yearly means of relative sunspot-numbers for the last seven years.

It may be as well, at this point, to mention certain fundamental facts about radio communication by way of the layers of the ionosphere. To effect long-distance communication in

amount of absorption increases towards the sunspot maximum, though not to a like extent as does the refracting power of the upper layers. As the amount of absorption is inversely pro-

portional to the square of the frequency, it follows that, in order to reduce it to a minimum, generally speaking, the highest possible frequency should be used, provided always that it is not too high to be refracted by the upper layer.

We see then that frequencies which are useful—and indeed necessary—to provide communication at the maximum of the cycle will become too high as the cycle progresses in its course, because the ionisation will become too low to ensure their refraction. Conversely, the highest frequencies which can be used at the sunspot minimum will become too low at other epochs, because they will become subject to high absorption as the ionisation in the lower layers rises.

Minimising Interruptions

What range of frequencies then is necessary in order to be able to effect communication by day and night, summer and winter, over a whole sunspot cycle? It is obvious that the question is an important one, affecting as it does the whole matter of the allocation of the available frequencies between the various services and stations. To find the proper answer to it we should have to make a detailed examination of a large number of transmission paths, running in all directions from a number of points on the earth's surface. And it is doubtful whether there is yet available enough ionosphere data from a sufficient number of points on the earth's surface for a true result to be obtained. The subject is, in any case, much too big for this article. However, we can at least examine one transmission path from this point of view, and possibly make some inferences to suit other cases.

First, the results of experience in the matter of short-wave working frequencies may be stated. For any particular short-wave route at least two frequencies (preferably more) are necessary if service is to be maintained throughout the 24 hours. A relatively high frequency is required for use by day and a relatively low one for night time use. A frequency intermediate to these is extremely useful (and in winter necessary) at the dawn and sunset periods. Seasonal variations must be taken account of as well as diurnal ones, so it is probable that a lower frequency will be necessary for the winter night than is suitable for the summer night, and a higher frequency for the winter day than for the summer day. It appears, therefore, that the minimum number of frequencies required for all-the-year-round communication over any transmission path

is four, i.e., (1) Winter Day, (2) Summer Day and Winter Intermediate, (3) Summer Night, and (4) Winter Night.

Of course, on certain circuits communication will become poor or even impossible at certain times of day, no matter what frequency is used. For example, when there is a great difference in longitude between the transmitting and receiving points large time differences will exist between them. Because of this, more particularly at certain seasons of the year, ionosphere conditions at the two points must be so greatly different that any frequency

effect of varying the useful elevation angle. The maximum usable frequencies indicated for 3,000 km. are about the highest one could ever use, which means that to serve nearer points in the U.S.A. somewhat lower frequencies than those indicated should be used, the waves taking off at somewhat greater angles.

The latitude of Washington is not greatly different from that of the two points where the wave undergoes refraction on this path, so perhaps the ionosphere data obtained there will be applicable also to these two points. The critical frequencies for Washing-

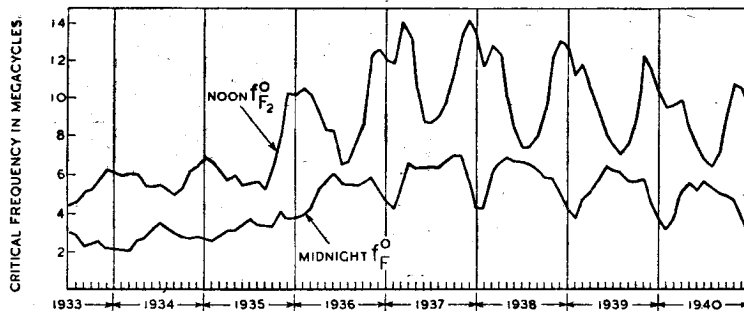

Fig. 2. Monthly average of noon (f_oF_2) and midnight (f_oF) critical frequencies at Washington.

which is at all suited to the conditions at one end of the circuit is bound to be completely unsuitable at the other. Thus, at these seasons, communication over such circuits is inevitably limited to something less than 24 hours per day.

Specific Requirements

To return to the main question—let us now examine a specific route in order to discover what range of frequencies is necessary in order to ensure communication for the maximum possible time over the whole sunspot cycle. For this purpose the ionosphere records for June and December of the years 1933 and 1937 will be relevant, for those were the conditions at the last sunspot minimum and maximum respectively. It can be assumed that during the intervening years, and also during the years between 1937 and 1944, conditions would be somewhere between these two extremes.

A suitable circuit would appear to be that between this country and the U.S.A., i.e., a transmission path running in a north-westerly direction from this country. If the length of such a transmission path is 7,000 km., the receiving point being assumed to be near Kansas City, it can be taken that the transmission will be by two hops, each of 3,500 km. Conditions as to virtual height vary somewhat during the year, but this will only have the

ton are regularly published in the Proceedings of the Institute of Radio Engineers of New York.

Fig. 3 indicates the average conditions which would be encountered on this path for two hops of 3,500 km. during the summer and winter of years at the sunspot minimum and maximum.

The full line curve represents what may be termed the "high limit" to the working frequency, any higher frequency tending to penetrate the refracting layer. This is obtained by calculating the MUF (maximum usable frequency) for 3,500 km. from the Washington critical frequency data, and then deducting a small percentage as a safety margin to allow for variations in the ionisation from the average for the month. The time differences from GMT at the two refraction points are then taken account of and the values shown only for that refraction point where the MUF is lowest, so that conditions for the transmission path as a whole are indicated in terms of GMT.

The absorption to which the wave is subject in the lower layers determines the low limiting frequency, and a rough guide as to this is given by the broken-line curves in Fig. 3, which are related to the critical frequency of the lower layers. These curves are not intended to indicate a frequency below which no signals would be

Maintaining S-W Communication—

receivable. Increases in absorption can be overcome by increases in transmitted power, i.e., the precise low limit to the workable frequencies will depend upon the power used. It is probable, however, that transmission on a frequency below that indicated by the broken-line curves would be a wasteful process, because of the higher losses due to absorption.

The range of frequencies for reliable communication over this path over the whole cycle would therefore appear to be from about 37 Mc/s to about 3 Mc/s, a number of set frequencies suitably spaced within this band being necessary if communication is to be maintained for the maximum possible number of hours daily. It may be somewhat surprising to see that frequencies above 20 Mc/s are suitable for reliable communication by way of the regular ionosphere layers at cer-

provides the worst conditions, with the band of usable frequencies at its narrowest.

Conditions which apply on a Great Circle path running in a north-westerly direction from this country would also apply on one running in a north-easterly direction, though the different values for the high and low limits would occur at different times of day. The range of frequencies for two-hop transmission would, of course, be the same. For one-hop transmission over these paths the range would be extended somewhat at the high-frequency end, while each additional hop would have the effect of lowering the high limit considerably. For circuits running in more northerly directions, the extreme high limit would also be somewhat lower than in the case shown in Fig. 3. Circuits running in more southerly directions would give rise to a variety of con-

lem. For the transmission path we are considering it appears that two channels would suffice for the summer months, one for daytime and one for night-time use. For the sake of argument let us suppose that these were—at the sunspot minimum—5.7 Mc/s and 12.3 Mc/s. At the summer of a sunspot maximum year the lower frequency would not be required, but an additional channel would be desirable for daytime use on a higher frequency. Suppose this were 16.4 Mc/s. These three channels would also probably suffice for the winter of a sunspot minimum year, but in order to reduce interference on the lower frequencies—where there would be a tendency to overcrowding of stations—it would be necessary to avoid the lower frequency channel whenever possible. So it would be very advantageous to have a channel between 5.7 Mc/s and 12.3 Mc/s, and this might be at 8.0 Mc/s. During the winter of a sunspot maximum year the higher frequencies would provide the most efficient channels for communication, and a higher frequency than 16.4 Mc/s ought to be used. This might well be 27.0 Mc/s. Thus our imaginary station would find uses for a total allocation of five channels.

It may be of interest to show the utility of frequencies allotted to amateur transmitters on this transmission path over the sunspot cycle, and the highest frequency in each amateur band which can be considered useful for long-distance working is shown by the horizontal markings at the left of the drawings. These bands were, of course, allotted on the basis of quite different considerations from those which we are now thinking of, but it is seen that, so far as this particular path is concerned, they suit the conditions pretty well, except in the summer at the sunspot minimum.

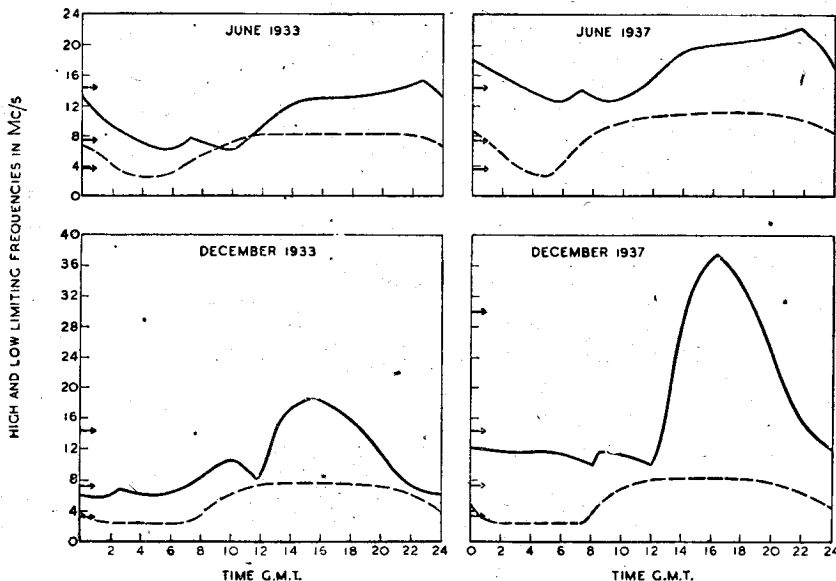

Fig. 3. High and low limiting frequencies for the summer and winter of years at the sunspot minimum and maximum for the transmission path to the U.S.A. by two hops of 3,500 km. each.

tain epochs of the cycle. That this is so, however, has been well proven experimentally. In particular, investigations carried out in Japan a little time ago show that waves between about 30 Mc/s and 40 Mc/s did indeed travel by way of the regular F₂ layer, and that such transmissions were reliable. We may, therefore, anticipate the use—during years around the next sunspot maximum—of much higher frequencies.

Fig. 3 shows that the sunspot maximum provides the best conditions for short-wave communication, especially in the winter, for then the band of usable frequencies is widest. The summer of a sunspot minimum year

provides the worst conditions, though it is unlikely that frequencies higher than those shown in Fig. 3 would be required. Altogether, it is probably true to say that the range of frequencies useful for world-wide communication over the whole cycle for a station in a middle latitude would be from about 30 Mc/s to 3 Mc/s.

The spacing of the actual working frequencies within this range is, of course, important, and it will depend upon the class of service on which a station is engaged, having regard to the allocation of the bands of frequencies among the different services. The minimum number of channels required is another interesting prob-

Slow Electrons

THE Behaviour of Slow Electrons in Gases," by R. H. Healey, D.Sc., F.Inst.P., and J. W. Reed, is published by Amalgamated Wireless of Australia and issued in this country by our associated journal *The Wireless Engineer*. From the purely wireless aspect, the interest of the subject matter is concerned with the effect of radio waves on the ionosphere, and especially in connection with the modulation process in the ionosphere known as the Luxembourg Effect. The authors acknowledge the work of Professor Bailey, of Sydney University, who presented a theory to account for the Luxembourg Effect in *Wireless World* for February 26th and March 5th, 1937.

The book costs 20s., or 20s. 6d. by post from Iliffe and Sons, Dorset House, Stamford Street, London, S.E.1.

Scale Distortion

Is It Really Distortion? — The Case for Frequency Correction

By A. S. EVANS

DISTORTION is an ugly word, and to the quality enthusiast it conjures up visions of conditions which are insufferable and demand instant correction. It is, perhaps, because of this that there has been much confused thinking about the subject of scale distortion.

It would appear from the many articles written on the subject that scale distortion is met with only when sound is reproduced by a loud speaker fed by an uncorrected straight-line amplifier, and this argument seems to have sprung from the false premise that the output from such a loud speaker and amplifier is itself level in regard to frequency.

The argument develops along the line that while the sound output at full orchestral volume is satisfactory, at lower levels of volume there is a disproportionate loss of the upper and lower frequencies. The cause of this, it is stated, is scale distortion.

Now in disproving this argument it is necessary to agree that scale distortion is not peculiar to mechanically or electrically reproduced sound, but is due to the comparative insensitivity of the ear to the extreme sound frequencies—a condition which becomes more pronounced at lower volume levels—and that no matter what the source of sound, the ear reacts in exactly the same way, and the result is scale distortion.

Natural "Scale Distortion"

In the concert hall, no matter where one sits or stands, the volume varies from one place to another, and because of this one has to put up with that nightmare of the quality radio enthusiast, scale distortion. The farther from the orchestra, generally speaking, the worse the distortion, but does one worry about it, or complain, or use some frequency-correcting gadget to clamp over one's ears? No!

It seems clear, then, that for the full enjoyment of a "live" performance, no matter how far from the orchestra one sits, so long as the sound is loud enough for comfortable listening there is no need for frequency-correcting devices, although scale distortion is inevitably present. The balance is automatically corrected

by that very peculiarity of the ear over which we have worried unduly.

In short, scale distortion is both necessary and desirable for realistic listening, because if correction is not needed when listening to a "live" performance, then it should not be necessary, or needed, when listening to radio reproduction, provided that the reproducing chain is itself not introducing distortion.

Now, granted all this, if we have a good radio transmission of an orchestral performance received by a good receiver coupled to an amplifier which will deliver to the loud speaker an exact copy of the original in terms of electrical energy, then we should be able to vary the volume of sound by means of the volume control in exactly the same way as we can vary the volume of the sound at the ear by moving away from the orchestra in the concert hall, and at the same time similarly to preserve the original musical balance at each gradation of volume. The effect, as heard, should be the same, because scale distortion is purely a product of frequency, volume of sound, and the peculiarity of the ear, which latter is totally indifferent as to the actual source of the sound.

In practice, however, there is no doubt that this most desirable result is not obtained when we listen to the sound reproduced by our baffle-mounted loud speakers.

Why not? Not because of scale distortion, because enough has been stated to show that this is necessary and desirable because it is present when listening to the original performance. So, if the sound as heard from the loud speaker is lacking in balance, then the fault lies elsewhere.

As already stated, the false premise is that the sound output of a baffle-mounted loud speaker fed by a straight-line amplifier is itself level and gives faithful reproduction at full orchestral volume. If it does so, then with the lowering of volume scale distortion by the ear would, as it does in the concert hall, automatically adjust the balance for realistic listening.

The fact is that the sound output of

a reproducing equipment, given a straight-line amplifier, follows the loud speaker frequency response curve. The writer suggests that to say that the loud speaker with a response curve which falls by even only 5 decibels at the upper and lower extremities will give well-balanced reproduction at full volume under the aforesaid conditions is simply not true. To give full orchestral volume a baffle-mounted loud speaker must be fed with something like 600 watts, and though under certain conditions about 50 watts will give the impression of full volume, it seems too much to expect any single loud speaker to handle this input. Even if a bank of loud speakers was to be fed with this input in a sufficiently large hall, it would be found that the result would be as lacking in balance, as might be expected from a study of the response curves.

The fault would appear to be, therefore, in the loud speaker; this, the writer believes, has been appreciated only by P. G. A. H. Voigt, whose horn-loaded loud speaker has been corrected for deficiencies in the bass by means of a "bass-chamber," making further correction in the associated amplifier unnecessary.

"Straight-line" Sound Output

It follows, then, as we cannot alter or improve the loud speaker itself—we must wait for the manufacturers to do this—that some correction must be introduced in the amplifier to make the *sound output* from our equipment truly "straight-line," and the writer will explain how this was done with his own equipment.

Most good loud speakers of to-day, especially the double-cone type, have a fairly uniform output upwards of about 700 c/s, but below this frequency the output is on a lower level, albeit only a few decibels, and this lower output must be brought up to the level of that above 700 c/s. Where the curve is level up to about 8,000 c/s, and then falls by up to 5 decibels to 10,000 c/s, correction at this end of the scale is not worth while in practice owing to the difficulty of avoiding an undesirable rise between 6,000 and 8,000 c/s. A circuit tuned to resonance at 10,000 c/s might

answer, but under listening conditions the curve seems to be sufficiently satisfactory as it is. Of course, great care must be taken to prevent loss of top in the input to the loud speaker, the tuned circuits of the RF stages needing special attention.

The loud speaker used by the writer is of a famous make, and, though it has not been extensively advertised in recent years, it is widely used where quality of reproduction is a first consideration. It has a rosin, curved cone—the curve being of small radius—with a felt surround which results in a remarkably uniform and non-resonant output in the bass.

Bass and Treble Correction

The heavy line in Fig. 1 shows the makers' response curve. It will be seen that correction is needed at both ends of the frequency range. The output has been corrected up to at least 15,000 c/s by using a small horn-loaded moving coil tweeter fed through a suitable filter and connected across the main loud speaker.

The output below 700 c/s needs to be boosted by about 10 decibels. The most practical method of bass boost, the resistance-condenser network, however, gives a rising bass characteristic which is, strictly speaking, not good enough. The writer, however, decided to use this method, but to use a combination which would give a slowly rising curve. The correction at 70 c/s, allowing for the fact that the loud speaker is mounted on a 4ft. by 7ft. baffle fixed in a corner of the room, should give a rise of about 10 decibels, or a voltage ratio of 3.2/1. To allow for a continuance of the rise below this frequency to compensate for losses owing to limita-

tion of baffle area, resistances of 200,000 and 40,000 ohms were chosen with a condenser of 0.01 mfd. The resulting output is roughly as the

dotted curve in Fig. 1, which, it will be admitted, is much better than the original.

As the receiver was used near the local station it was found that with a fully loaded diode detector it was not necessary to employ a separate tone-control stage. The resistance-condenser network (shown in Fig. 2) was placed between the diode load and the phase-changer valve with very satisfactory results.

Now the proof of the pudding is in the eating, and one has only to listen to the reproduction from a loud

speaker, of which the response curve has been corrected in the way described, to realise that we no longer need to worry about scale distortion. It would be better to convince the loud-speaker manufacturers that they must redouble their efforts to produce a straight-line output loud speaker. The writer is convinced that the remedy will be found in the infinite-baffle type of loud speaker. This type is capable of an extremely smooth and low bass response, but care must be taken not to mask this by the usual rise in output between 1,000 and 6,000 c/s, which rise, besides robbing the bass of its beauty, results in a certain thinness of reproduction, if not a tendency to hardness.

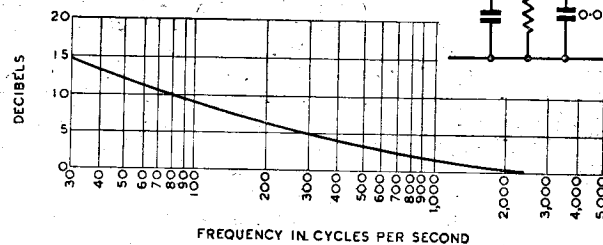

Fig. 2. The correcting circuit used and the resultant curve to be expected.

amplifier to realise truly realistic reproduction.

Cementing Bakelite

A NEW adhesive specially developed for use with cured synthetic resin articles has been marketed under the name of "Ardux" by Aero Research, Ltd., Duxford, Cambridgeshire.

We have examined a joint made between two sheets of cloth reinforced synthetic resin, and have little doubt that the strength of the adhesive is comparable with that of the resin. The adhesive is highly reactive, and makes intimate contact with polished surfaces. It requires baking at a temperature of not less than 140 deg. C., and will set in six minutes at 155 deg. C.

Two grades are available: Ardux 1 for close-fitting joints, and Ardux 2 for gap joints such as might occur when cementing metal inserts in mouldings and laminated sheets. It has already found application in wireless work for the fixing of components by means of studs at the back of panels without showing screwheads on the front. When replacement of broken mouldings is difficult, they can be successfully repaired with "Ardux."

As the life of the cement in liquid form is limited to one month, the makers have made arrangements to supply in small quantities. A two-ounce jar costs 2s. 6d. for Ardux 1, and 2s. 9d. for Ardux 2, post free, and 1 lb. jars are 10s. and 11s. respectively.

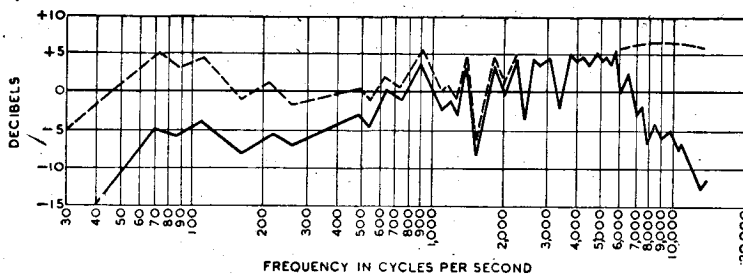

Fig. 1. The heavy line shows the response curve of the writer's loud speaker before correction, and the dotted line the approximate curve after correction. The decibel scale has been opened out to give a clearer effect of the result obtained.

tion of baffle area, resistances of 200,000 and 40,000 ohms were chosen with a condenser of 0.01 mfd. The resulting output is roughly as the

that when loud-speaker manufacturers resume their advertising in the piping days of peace, they will be able to add to the claims they make for the merits

The Eckersley Plan

Suggestions for a Post-War Broadcasting Service

In last month's issue the former Chief Engineer of the B.B.C. explained the technical means of distributing broadcasting over the electrical supply mains. He now makes suggestions for a post-war system of distribution depending mainly on wires, with radio as an ancillary service

By P. P. ECKERSLEY, M.I.E.E.

I RECOMMEND a study of Sir Noel Ashbridge's recent Presidential Address to the I.E.E. In dealing with possible futures, Sir Noel debunks rosy dreams and warns us that it may well be more difficult to organise peace than war.

My article disregards the means to a chosen end, and assumes they will be found.

Suppose, then, that the will and a way to an ideal broadcasting service exists when the war ends; what would be this ideal? Broadcasting is only important if the listener listens. The listener will only listen if there is something he wants to listen to. Broadcasting is not a necessity like food; it is an amenity, a very influential amenity, of contemporary life. Life would not cease if books were unobtainable, or if music were no longer played, or if public speaking were forbidden. Even newspapers, even broadcasting, are not vital necessities. But such things have become so seemingly essential that life would be dreary if we had to go without them. And—here is the point—as such amenities become more stimulating, more amusing, more interesting, they make the business of living more tolerable—even, at times, acceptable. The ideal broadcasting service is therefore one in which the "true intent is all for your delight."

Such an ideal cannot be realised unless broadcasting reflects the diverse pattern of sentient life; it cannot come near its real function unless it can satisfy, at all times, a taste, a mood, or an interest.

If we accept this view (a view surely in sympathy with our stated post-war aims), then the technician must design a system of broadcasting apt to the function.

There are two contrasted schemes by which broadcasting could become that "rostrum of democracy and

patron of the arts" which synthesises my ideal. In both schemes a large number of programmes would be "on tap"; in both reproduction would do justice to the original, in neither would "background" destroy enjoyment, and the cost of either would be within the means of all.

USW or Wire?

In one scheme, outlined by Mr. Butt¹ in a recent article in *The Wireless World*, ultra-short waves would be broadcast through the ether, to be picked up by radio receivers; in the other scheme wires would guide the waves to their chosen destinations in listeners' homes. The contrast is between a system in which waves escape and are picked out of the ether and one in which an artificial ether is given the inescapable boundaries of a conducting network. The ultra-short-wave radio system has the advantage over the present radio system that many more channels can be found in the high-frequency gamut than in the medium-wave band and that, owing to their smaller range, there is less likelihood of interference between "distant" and "local" stations than exists in present practice. In wire systems there need be no limit within reason to the number of channels that can be used simultaneously.

The following points seem to me to lead to the conclusion that the wire system is the better. I shall state these points baldly and comment upon them afterwards in more detail.

First—a basic point in sane planning of communication systems is that radio should never be used if a wire communication would serve instead.

Secondly—a communication system, to be really satisfactory, must be de-

signed as a whole, taking into account the characteristics of transmitter, receiver and channel in relation to one another, so that each shall be efficiently combined to give a desired result.

Thirdly—consideration of cost should be related to expenditure as a whole and not as to the capacity of individual interests to furnish capital or make profits.

Expanding and justifying my first point, it is surely obvious that radio is essential for what are called "mobile services" (namely, communication to ships, aircraft, trains, motor vehicles and so forth), it is a mere convenience where a wire attachment can be maintained. Therefore, before squandering the limited facilities of radio, the essential demands must first be satisfied. In other words, mobile services have first claim, and, as I see it, legitimate demand may well exceed supply. The safety of life in the air, for instance, will depend more and more upon radio, and, after the war, more and more of our lives will be spent in the air. Radio, furthermore, is rapidly overcoming the limitations of human sight and hearing, making travel safer and more reliable. The detection of crime and apprehension of those boring gangsters will be made easier by radio, let along the therapeutic values of ultra-ultra short wave radiations. With so many actual—and who knows how many potential—values of radio, it would be foolish to use up facilities unnecessarily.

Unified Control

A story is relevant to underline my second point, namely, that one authority should, in the final issue, be responsible for any communication system as a whole. When I was Chief Engineer of the B.B.C. I gave an "informal" lecture to the I.E.E. on the subject of receivers for broadcasting. A senior official of the technical department of the Post Office—rightly famous for his wit and forthright expression of opinion, said, during the discussion: "It seems to me that Eckersley would be better employed getting transmission right than holding forth in this lordly way about the subject of reception, of which he obviously knows very little." I replied to my critic asking him how he, as an engineer, would feel if Post Office

¹ "Planning Post-war Broadcasting," *Wireless World*, November, 1941.

The Eckersley Plan—

responsibility for the telephone service were to cease at the point where their wire entered the subscriber's premises and if the subscriber were permitted to attach to such wires any instrument either bought under the influence of advertisement, or, worse still, home-constructed from the dangerous possession of a little knowledge and less money. The rules governing I.E.E. meetings gave me the last word, but I felt that I had it in any case.

In radio broadcasting one authority is responsible for transmission and a lot of people, often successful because they are better salesmen than technicians, provide facilities for reception. Even if it were possible to rule that every receiver had to conform to a specification, and if this specification were simply based on performance, I suggest it would be more difficult and more costly to fulfil it in radio than in wire broadcasting technique.

Signal/Noise Ratio

Consider the simple point of the relative amounts of amplification necessary in either system. It is possible that the signal-to-noise ratio might be sufficiently favourable in either system, but in radio practice the absolute strength of the signal would be, on the average, smaller, because it would be extravagant to make it as large as is economically possible when wires conduct the signal to the receiver—kilowatt for kilowatt of transmitter power, radio versus wire, the signal strength on the wire is vastly greater.

Hence, because the power required to make the loudspeaker speak loudly is a constant, the wire receiver requires, in practice, fewer valves. Fewer valves means less power consumption, less complication, fewer replacements and thus—most important advantage—less bulk of apparatus for a given fidelity of reproduction. And, of course, the simpler set is the cheaper set. It seems as if the rooms we shall live in for the next few decades will be as small as our incomes, and so the cost and bulk of "the wireless" are vitally important factors.

Apart from such obvious points, I wish again to stress how advantageous it would be if transmission and reception should combine their virtues and cancel their vices.

Impartial judgment might, on the cited points, lean towards my conclusions, but might well be reversed if comparisons were made in terms of "commercial considerations." Thus it might be argued that it would not be beyond the financial resources of

the B.B.C. to build a number of ultra-short wave transmitters and that the burden of equipping the listener with suitable receiving sets could well be taken by the listeners themselves. Or, going farther back, by the financial operations of set manufacturers. This method was adopted in building up our present scheme; why not use it again? This is all true, but, looked at from a community point of view and disregarding the means to obtain capital from individual sources, it would be more economical to install a wired rather than a new wireless system. This is because the wire network could be installed once and (nearly) for all, making the consumers' apparatus, which wears out comparatively quickly, much cheaper. There is the further but very pertinent point, that the wire network, besides bringing sound and vision programmes to the listener, besides overcoming interference completely, besides cheapening and shrinking the size of the listening apparatus, might also be used for the telephone and facsimile services.

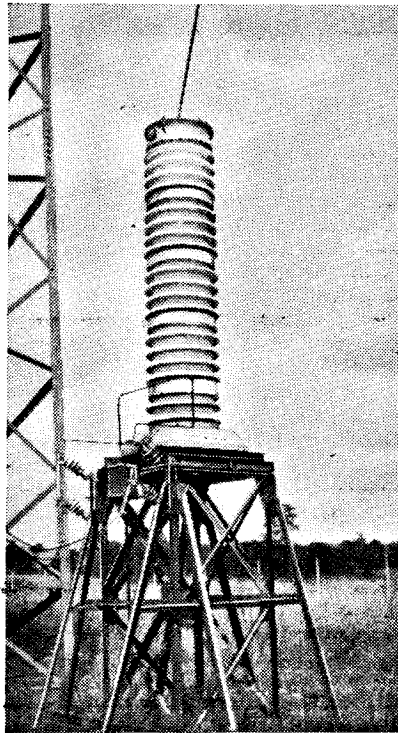

Our contributor admitted last month, when discussing wired wireless broadcasting over the mains, that kilovolts terrified him. Nevertheless, carrier systems are sometimes employed on high-voltage lines; this 0.001 mfd. coupling condenser is used for picking off the carrier current from a 220 kV line.

An argument has often been adduced against the use of the wire which says that the total supercession of wireless would forbid nationals overhearing what is going on in other countries. Each nation, proud of its culture, wants others to listen and learn.

While certain that the basis of broadcasting should be a wired system, I agree that it would be a thousand pities if this forbade overhearing between nation and nation. I might argue that the international trunk telephone system could be equally used to link studio with studio in a continent as the national trunk systems change the focus of a programme within national boundaries. But perhaps this suggestion leaves an authoritarian flavour; who is to choose what we shall or shall not hear? I must stick to my role of optimist and believe that the authorities of the future will be as wise as they are witty and as informed as they are tolerant. Having done so, I will admit special pleading and agree that long-range wireless services, in some form, should remain as ancillary to those given by the wire. This would seem to me to be necessary whether we used ultra-short waves or wire technique to distribute the bulk of the programmes, because the range of ultra-short waves is restricted.

Summing up, then, my plan is to wire Britain for sound and vision, but to preserve some short-, medium- and long-wave stations so that our liberty to hear across frontiers is still preserved. I think, in this connection, if each cultural centre of Europe—that is to say, broadly speaking, each nation—were to possess one longish wave, and if the frequencies of the carriers were spaced 20 k/cs apart, and if the sending power were unlimited, then the needs of the wireless broadcasting services would be met.

To ensure diversity, to satisfy minorities, to preserve free speech, to realise, in fact, the real potentials of broadcasting, I would plead for the use of the wire. The planning, building and maintaining of such a national system, based on the vast amount of knowledge gathered since the valve was put into use, could ensure the employment of large numbers of technicians, now working on war wireless, who might otherwise find it very difficult to get a job commensurate with their abilities.

It is curious to think that Lord Reith, who did so much to establish the foundations of our broadcasting service, might, in his present capacity, build on these foundations an edifice of real consequence.

Portable HT Batteries

Recent Improvements in Volumetric Efficiency

THE popularity of the "personal portable" in America led to a re-examination of the design of small HT batteries such as those used in "all-dry" portables to see if their weight and bulk could be still further reduced while maintaining acceptable standards of power output. From accounts so far published,¹ it would appear there is no immediate prospect of any fundamental electro-chemical improvements in the electrodes or electrolyte (primary cells were one of the earliest studies of applied scientists) and that the problem resolves itself into one of mechanical design and the reduction or exclusion of non-active materials and unused spaces from the available volume.

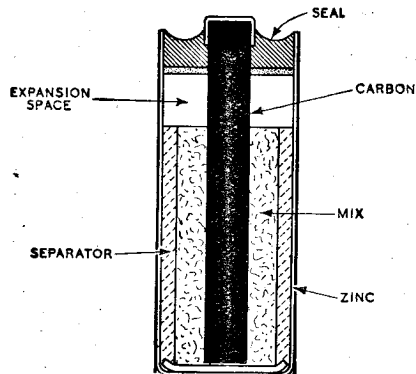

Section of conventional cylindrical-type dry cell.

The conventional cylindrical cell is particularly wasteful, due to the large volume usually allowed as space for the expansion of the electrolyte and depolariser "mix" and for the wax seal at the top of each cell. In a typical case, the percentage of the total volume of the cell occupied by the "mix," which can be taken as a criterion of the efficiency of the cell, was only 35 per cent. Allowing for the space wasted between adjacent cells when packed in rows in a rectangular carton, the final volume of mix becomes only 25 per cent. of the whole battery.

To improve upon this unsatisfactory state of affairs, the flat-cell battery was introduced about fifteen years ago.

A standard "all-dry" 45-volt HT unit (left) compared with a new compact battery of the same electrical capacity. The valve is a bantam type with international octal base.

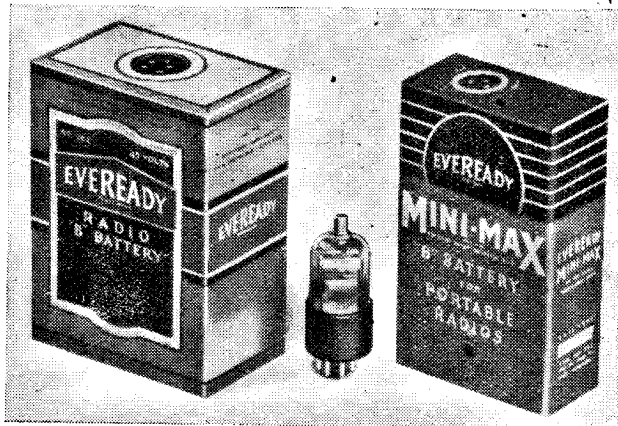

In this the carbon and zinc electrodes were in the form of plates mounted back to back, and the mix was made into a cake which was sandwiched between pairs of electrodes. Depressions moulded into the face of each mix cake served as expansion spaces and short porous carbon rods let into each cell acted as gas vents. The exposed edges of the electrode plates, which extend beyond the mix cakes, were finally embedded in wax to prevent inter-cell leakage.

With this method of construction the capacity per unit volume is about 25 per cent. greater than that of batteries assembled from cylindrical cells. The improvement would be greater were it possible to extend the mix cake to the edges of the electrodes, but with the original flat-type cell this cannot be done, neither can the amount of wax be reduced without prejudice to the life of the cell through internal leakage.

In the latest type of flat cell, the problem has been solved by using a separate peripheral wrapping for each cell. This is usually of rubber or one of the newer plastic materials, and it not only allows the mix to be extended right up to the edge of the plates, but

retains the electrolyte without additional sealing at the edges. Also, the resilient nature of the wrapping permits expansion due to chemical action during discharge, and the edge of each cell is chamfered slightly to allow just the excess volume required and no more.

The standard HT voltage for personal portables is 67.5 volts, and batteries of this voltage with cells of less

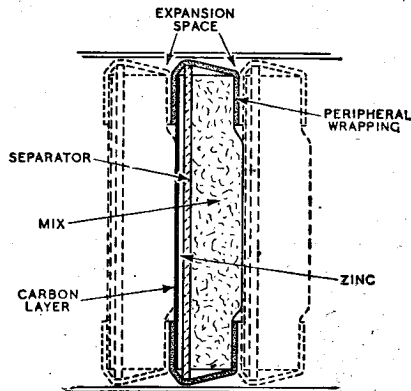

Inter-cell leakage is prevented and expansion permitted by the flexible wrapping of the latest flat-type dry cell.

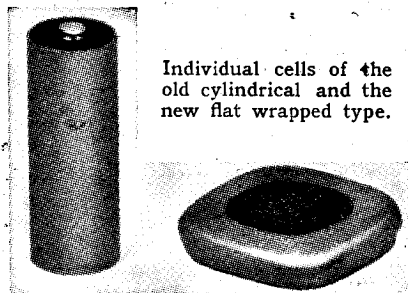

Individual cells of the old cylindrical and the new flat wrapped type.

capacity than standard portable batteries are being made for use with the economical miniature valves employed in sets of this type.² For existing "all-dry" portables, 45-volt wrapped cell HT units of the same capacity as the older standard types are available. They occupy half the volume and have only two-thirds the weight of the conventional cylindrical cell type.

¹ "Improvements in B-Battery Portability" by H. F. French, *Proc. I.R.E.*, June, 1941.

² See *The Wireless World*, August, 1941.

Amateur Two-way Television

Experiments in America

WHEN commercial broadcasting was first introduced, it was not long before the transmitting amateur availed himself of the new technique to improve the quality of his telephony modulation, and for all but long-distance contacts, morse signals were soon displaced by speech. Judging by recent reports,¹ it would seem that a similar transitional stage towards television and "seeing the fellow at the other end" has been entered upon by the more enterprising among American enthusiasts.

It is safe to say that the starting point of this new movement was the introduction last year of the R.C.A. Type 1847 iconoscope, which made possible the transmission of high-quality pictures on the amateurs' own band of 112-116 Mc/s ($2\frac{1}{2}$ metres). The new tube is about $7\frac{1}{2}$ in. long, and 2 in. in diameter. The photoelectric mosaic is transparent, and the particles are attached to the back of the plate, i.e., when viewed from the image-forming lens. The front of the plate carries a translucent conducting film which acts as the signal electrode, through which the light passes on its way to the mosaic particles.

¹ "Television System for the Radio Amateur" by L. C. Waller and P. A. Richards, *R.C.A. Review*, Oct., 1941.

The new R.C.A. Type 1847 amateur iconoscope (left) compared with a standard professional type.

The mosaic is at right angles to the electron stream from the exploring gun, and simple linear scanning may therefore be employed without the necessity for the "keystone" correcting circuits necessary with the larger commercial iconoscope in which the face of the mosaic is scanned from a point off the axis. The electron beam is controlled by deflector plates at right angles and the sensitivity is the same as that of the Type 902 monitoring tube, which may be connected in parallel with the iconoscope as an electronic view finder.

Coupling to the signal electrode is made through the capacity of an external metal band, and the signal output is therefore of negative polarity, i.e., high lights give a negative, and shadows a positive signal voltage. This point has to be borne in mind when deciding upon the number of stages between the iconoscope and its monitor, otherwise a negative image

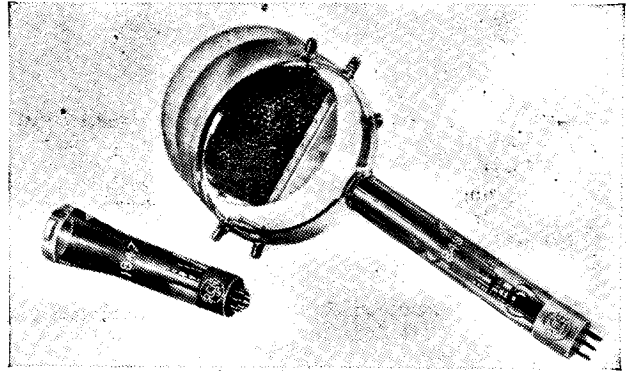

may result. The tube works with the comparatively low second anode voltage of 600, and its filament rating is 0.6 amp. at 6.3 volts.

Camera-Modulator

As the optical image required is only 2 in. in diameter, a special camera lens is not necessary. In practice a 35 mm. film projection lens of 3 in. focus and aperture of $f/2.3$ was found satisfactory. In the camera unit designed by J. B. Sharman, the iconoscope and monitor tubes are mounted back-to-back on top of the chassis carrying the modulator circuits. This makes a compact unit with no complications in the way of low-capacity camera cables and auxiliary leads for power and scanning voltages. There are five video stages terminating with a 6L6 modulator valve. Sync pulses are applied to the screen of this valve and blanking signals to the suppressor grid of the previous stage. The sync pulses are of the same polarity and 25 per cent. greater amplitude than the blanking signals, so that synchronising is not affected by the picture level. Negative feedback and frequency correction for high frequency loss due to the comparatively high input load of 0.5 megohm is applied in the second stage.

Since the first three stages of the amplifier are called upon to deal with high frequencies only (there is no DC component with this particular design of iconoscope), high-pass intervalve couplings can be used to exclude hum pick-up, etc. The fourth and fifth stages are, of course, designed to transmit the 30-cycle blanking and sync signals.

About 30 volts is available from the cathode circuit of the 6L6; this is

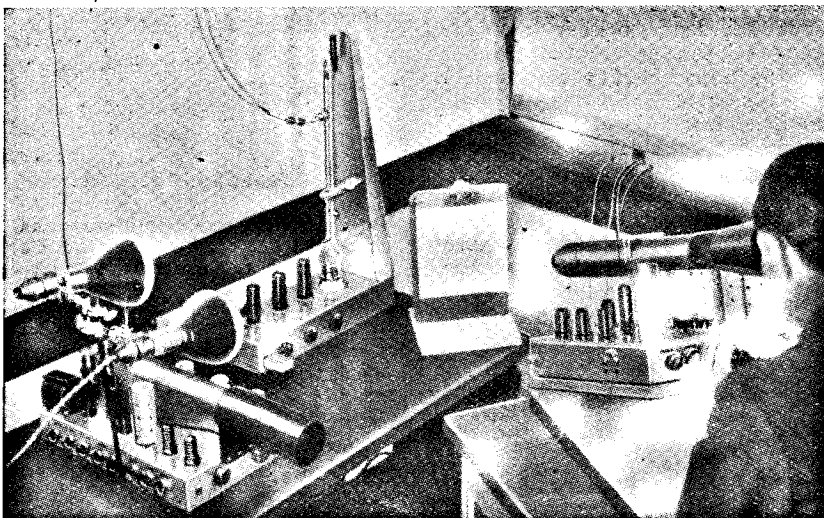

General view of a complete amateur television transmitting station. The operator on the right is viewing the test image on the combined iconoscope and monitoring tube. In the centre is seen the $2\frac{1}{2}$ metre transmitter while on the left immediately below the two spot light lamps is the receiver.

more than sufficient to modulate the grid of the Type 829 twin-beam power amplifier used in the radio frequency transmitter unit. In accordance with American practice, an increase in carrier level represents a decrease in illumination, and the modulator output is therefore taken from the cathode circuit of the 6L6 valve. The output from the monitor tube requires the opposite phase and is taken from a load in the anode circuit. Switching enables the monitor tube to be used for viewing the wave forms of the output, and it is possible to examine the contents of a single line of a complete frame or the input to the aerial system via a suitable detector unit. In the interests of economy, blanking and sync signals are derived from the scanning oscillators, the vertical sync pulse being derived as a sub-harmonic of the 60 c/s supply mains.

2½-metre Transmitter

A transmitter circuit which has been designed for use with this modulator has a four-stage circuit controlled by a crystal with a fundamental frequency of approximately 7 Mc/s. The oscillator stage is of the "Tri-tet" type which quadruples the output frequency to 28 Mc/s. The second and third stages are frequency doublers,



Photograph giving some idea of the quality of the received picture.

which bring up the input at the final stage to 112 Mc/s. The Type 829 power amplifier in this stage is a twin-beam tetrode worked in push-pull at the comparatively low plate voltage of 500, and delivering a carrier power output of 23 watts when adjusted for grid modulation. The output circuit is a quarter-wave resonant line and a plate efficiency of 35 per cent. is claimed. Capacitive coupling to a 470-ohm non-resonant transmission line feeds a three-element close-spaced beam aerial system.

Using a transmitter and modulator

Greetings to Our Readers

Last year we compared our situation with that existing within a beleaguered fortress, but did not think it inconsistent with the spirit that should prevail there to offer the usual Christmas Greetings to our readers. The situation has improved and the confidence then felt has been strengthened by the events of the past year, but it is in the same spirit that the Editor and staff of "Wireless World" tender their sincere good wishes for Christmas and the New year to all members of the ever-growing family of wireless. Our thoughts go out especially to those in the Services, who are playing such a vital part in the war.

of this type, pictures were successfully transmitted over a distance of 1½ miles at Delawanna, New Jersey, and from the signal strength available it is expected that ranges of 10-15 miles should be possible in favourable circumstances. At the Radio Parts Manufacturers' Trade Show held in Chicago on June 11-14th, 1940, the apparatus was demonstrated continuously for 12 hours per day without breakdown.

The cost of the television transmitting station should be well within the resources of the amateur; the iconoscope costs about the same as a 5in. television tube for reception, and as the operating voltages are all comparatively low, standard HT rectifying and smoothing equipment may be used.

Alternative Valves

A Handy Wartime List

THE tabulated list of valves recently prepared by the British Radio Valve Manufacturers' Association, and issued by *Wireless World* at the cost of a shilling, is proving extremely useful to those who find themselves in the position of being unable to obtain a replacement for some valve in their sets which has failed through accident or old age. It enables them to see almost at a glance what valves there are that can be used as alternatives to the one which has expired.

In order to get the best out of the list it is, however, important that it should be used correctly. This is not very difficult, as any valves which are printed on the same horizontal line

are mutually interchangeable irrespective of make. Valves which are likely to prove difficult to obtain are printed in ordinary type, under a special column heading, while those which are more likely to be obtainable as replacements are printed in heavy type under the column heading of "Recommended Alternatives."

There should be no difficulty if it is remembered that all valves which are printed in either ordinary or heavy type can be mutually exchanged provided that, as already mentioned, they are on the same horizontal line. The only exception to this rule is that in those cases where there are several valves of the same make which are mutually equivalent they are printed together in a vertical column, but as these are always bracketed together no difficulty should arise.

In some cases certain valves are shown in heavy type which have no others on the same horizontal line to keep them company. This merely means that these valves have no equivalents, but as they themselves are likely to be readily available—as indicated by the heavy type—all is well.

Empire Broadcasting

Progress and Prospects

IN a recent review of broadcasting and the war given to members of the Royal Empire Society, Mr. F. W. Ogilvie, Director-General of the B.B.C., gave some interesting facts about the B.B.C.'s World Service, which has grown out of the Corporation's original Empire overseas services. As is well known, overseas broadcasting began nearly nine years ago with a staff of six and a programme allowance of £10 a week. Thus were laid the foundations of the present vast and intricate structure which now uses 39 languages and runs for between 50 and 60 hours every day.

Mr. Ogilvie asked his audience to forget for the time being about the B.B.C., the M.O.I., and all that, and try to look at Empire broadcasting as a whole. "What do we see?" he asked. "In the Dominions and India strong national broadcasting systems are established. . . . The Empire service in Britain could not have grown as it has without those sister organisations. And in spite of the war, or rather because of it, practical day-to-day co-operation between broadcasters up and down the Empire has steadily increased."

In the Colonies, broadcasting has,

Empire Broadcasting—

of course, developed more slowly, but in several of them stations and systems of rediffusion were in operation before the war, and these have proved their value to imperial broadcasting.

Because of the fact that short-wave listeners in all countries are relatively few compared with the number listening on medium waves, rebroadcasting is of paramount importance. Figures given by Mr. Ogilvie showed that for an average of nearly sixty hours a day B.B.C. programmes are rebroadcast in Canada, South Africa, Australia, New Zealand, India, Singa-

pore, Ceylon, Bahamas, Newfoundland, Southern Rhodesia and Hong Kong, and rediffused in Nigeria, Malta, Sierra Leone, Barbados and Trinidad.

"The aim of Empire broadcasting," said Mr. Ogilvie, "is to interpret our ways and institutions to one another, to uphold our common ideals, to strengthen our friendships, to keep clean and clear the foundations of our life. . . . For the issues of this war are being fought out not only on the battlefield; they are being fought out continually in the minds and the hearts of men."

Book Review

The Power Behind the Microphone.

By P. P. Eckersley. Pp. 230+25.
Jonathan Cape, 30, Bedford Square,
London, W.C.2.

It comes as rather a shock to realise that there has arisen a wireless generation that knows not its Eckersley. But here is an opportunity for younger readers to fill up a gap in their education, and for older ones to renew an acquaintanceship to which they must look back with pleasure. The former Chief Engineer of the B.B.C., one of the outstanding personalities brought forward by broadcasting, reveals himself in this book as unchanged in all that matters by the passing of time. True, his range of interests has obviously been greatly widened, but, although this is not primarily a technical book, he still sees broadcasting through the eyes of a technician. For that reason alone the book is one that can be commended to *Wireless World* readers.

How Broadcasting Began

As a book "The Power Behind the Microphone," as might be expected, conforms to no set pattern. One would not have it otherwise. It starts with autobiography, continues with the foundation and early history of broadcasting in this country, and leads up to a fervent advocacy of "wired wireless" broadcasting. The development of the author's system is described at length, as are the obstacles encountered in his efforts to put it into practical effect. There are numerous and lengthy digressions; broadcast advertising, television, international conferences, audio-frequency relays, television. All is enlivened by witty and epigrammatic "Eckersley-isms." Perhaps the least satisfying part is that in which the B.B.C. is criticised. But though the criticism is devastating, it

is good-humoured, and behind it is obviously a sincere desire to see the vast potentialities of broadcasting used to best advantage.

The book is more than entertaining; it also makes valuable contributions to recorded wireless history. For example, it gives the reader peeps behind the scenes which help him to form a picture of how our broadcast distribution system came into being. It must not be forgotten that on this matter the author speaks with great authority; his conception of the Regional System brought him world-wide recognition.

Provocative and Stimulating

There is probably not a single reader of the book who will agree with everything in it. But that is all to the good; the author is the kind of man with whom it is a privilege to disagree. He is provocative and stimulating; he gives information and views on all the diverse aspects of broadcasting, and makes the reader think things out for himself.

One could quote hundreds of Eckersley-isms, but a single one must serve to give the flavour, but not the scope, of the book. The author, advocating headphone reception of school broadcasting, writes:—"The loudspeaker, competing against the too often atrocious acoustics of a schoolroom, and energised from a cheap receiver, makes children concentrate more on hearing than on the subject-matter of what is heard. I have been told that headphone bands would get lousy from contact with unwashed heads. But I would prefer lousy headphones to a lousy education."

Defending his ideal system of broadcasting, the author says: "I know of no other serious arguments against wire broadcasting which are worth re-

peating and refuting here. The wireless trade say, of course, that the institution of the system would throw tens of thousands out of employment because the public would give up using wireless sets and the wireless manufacturers and traders would, therefore, be ruined. This reminds me of the indignant Labour leader who, looking at a steam shovel, exclaimed: 'There, rationalisation! That machine replaces fifty men with shovels.'

"Yes, and ten thousand men with teaspoons," replied a logical spectator.

"Wire broadcasting would divert profits, not destroy them, it would change the character of employment, not diminish it. Besides, wireless manufacturers would still have to make wired wireless receivers."

H. F. S.

"Learning Morse"

A New Edition

THE staff of *Wireless World* takes pleasure in the knowledge that a large proportion of the operators now in the fighting services must have acquired their first knowledge of the morse code and of operating technique through our booklet, "Learning Morse," of which roughly 200,000 copies have been issued since the outbreak of war. A new edition—the ninth—has just been published.

In the preparation of each successive edition of this popular booklet we have benefited by suggestions from readers, and perhaps most of all by queries from beginners asking for advice on how to overcome their initial difficulties. One of these difficulties is with regard to the practical details of morse key manipulation. What is universally accepted as the correct method seems at first to be awkward to those who have been accustomed all their lives to performing apparently comparable operations in quite a different manner. But the correct wrist action, so essential to good operating, should be acquired from the start, or a bad habit that is difficult to break will be formed. In the latest edition there is described a simple practice exercise which has proved helpful; it virtually prevents that "finger-tapping" action which is fatal to good operating. Other minor additions and revisions have been made.

"Learning Morse" is obtainable from booksellers or bookstalls, price 6d., or by post direct from our publishers, price 7½d.

THE WORLD OF WIRELESS

NEW INTERNATIONAL STATION

S-W Transmissions to the Orient

WHEN announcing the licensing of the second international short-wave station on the Pacific coast of America, the Federal Communications Commission stated that "the desirability of broadcasting across the Pacific is self-evident in the light of International conditions."

The licence for a 100-kW transmitter to be erected at San Francisco has been granted to Associated Broadcasters Incorporated, who operate the medium-wave station KSFO. Special arrangements have been made with the G.E.C. to expedite the delivery of the transmitter.

The frequencies allocated to the new station are 6.06 Mc/s, which it will share with WCBX and WCRC, 9.57 and 11.87 Mc/s, shared with WBOS, 15.35 Mc/s, shared with WRUL and WRUW, and 17.76 and 21.61 Mc/s exclusive. Transmissions of news and entertainment in English, French, Spanish, Portuguese, Japanese, Dutch and possibly Russian, Thai, Chinese and Korean, will be radiated for from 16 to 20 hours a day.

"B.B.C. AT WAR"

THE changes and developments in British broadcasting since September, 1939, are told in the illustrated booklet with this title, published by the B.B.C. Readers will find that, although much of the information therein is already known, some of the facts have not previously been published, and the whole story, therefore, makes interesting reading. As might be expected, little, if anything, is disclosed of the technical changes or developments.

To mark the occasion of the publication of the booklet, which costs 6d., Sir Allan Powell, Chairman of the B.B.C. Board of Governors, spoke at a Press conference. He disclosed among other things that the Corporation now employs four hundred women on the maintenance staff.

R.A.F. WIRELESS ENTHUSIASTS

Appeal for Gear

AN R.A.F. Radio Club, just formed at an isolated station in the south of England, appeals for unwanted gear and components—valves, resistances, transformers, condensers, etc. The appeal is supported by the Officer Commanding, who tells us that all the members are keen wireless men. Offers of gear, if sent to this office, will be forwarded.

"SONOVOX"

Sound Effects with Electro-Acoustic "Vocal Chords"

IN animated cartoon films it is quite usual for such things as railway engines, steamboats and aircraft to assume personality and take part in the action. Often they are required to speak and in that event the voice must have the tone quality usually associated with the noise made by the original object.

The method by which this effect is produced is interesting. A steady tone is generated electrically with the correct admixture of harmonics required to imitate the characteristic noise. This is then applied to two moving coil units having cork pads attached to the coil instead of the usual diaphragm, and the pads are held in contact with the skin on each side of the throat. The articulator does not use his own vocal chords, but merely shapes his mouth and lips as though speaking the required words and the change in shape of the resonant cavities is sufficient to modulate the steady sound from the "Sonovox" units into clearly articulated words.

There are many possibilities of the "Sonovox" principle, including the re-articulation of singing voices in another language, and the articulation of words in the tone of circular saws, railway whistles and other sounds outside the range of the human voice.

The inventor is Mr. G. M. Wright, of Los Angeles, and commercial arrangements are in the hands of Wright-Sonovox, Inc., Chicago, U.S.A.

FM SIGNALLING SYSTEM

A BASICALLY new use for frequency modulation, owing to its freedom from interference, has been found at the U.S. Army's new 15,000-acre Elwood shell-loading plant in Illinois. According to the journal *Time*, the nine diesel-electric locomotives used for shunting explosives around the 100-mile track are being equipped for two-way FM communication. The system will dispense with the necessity of the conventional type of signalling.

CENSORSHIP IN AMERICA

THE appointment of a co-ordinator of information by President Roosevelt is foreseen in America to foreshadow the possibility of the Government controlling the international broadcasting activities of the various organisations. *Broadcasting*, Washington, D.C., points out that for several months the operation of the international stations has been co-



"SONOVOX" units (above) resemble moving coil earpieces. (Right) Ready for action. The "carrier" tone in this case is the sound from an electric bell, held by the inventor on the left.



Courtesy "Broadcasting"

A demonstration of the technique is given in Walt Disney's recent film "The Reluctant Dragon," which takes the audience behind the scenes during the recording of the sound accompaniment to one of his cartoons.

ordinated "from the programme-news standpoint" through the State Department's Division of Current Information.

The censorship of all incoming and outgoing international cable and

The World of Wireless— radio communications was also mooted before the outbreak of the war between the U.S.A. and Japan. Whether or not this will cover international broadcasting is not known; as an "external communications operation," it comes under the jurisdiction of the U.S. Navy in time of war.

INTERNATIONAL WAVELENGTH NEGOTIATIONS

Death of a Pioneer

THE death of Maurice Rambert, which occurred on October 21st, will be recorded in the hearts of many Europeans who took part in the proceedings of the Union Internationale de Radiodiffusion, where the vexed

are as free from interference as the older sets they replace. . . . The trouble is not so much adjacent-channel interference as it is trick pick-up of signals properly distant on the dial."

The chief cause is apparently due to the sacrificing of circuit refinements "once considered essential and added to ensure foolproof reception," for "visible sales features." It is claimed that this applies not only to the cheaper receivers, but also to the relatively expensive models.

B.B.C. TRANSMISSIONS

TWO new wavelengths in the 49-metre band, one just below the 41-metre band and one just above the 25-metre band, have recently been employed by the B.B.C. for the European and Near East Service. The new frequencies and call letters are:— 6.18 Mc/s (48.54 m) GRO; 6.19 Mc/s (48.43 m) GRN; 7.32 Mc/s (40.98 m) GRJ; and 11.68 Mc/s (25.68 m) GGR.

The latest schedule of news bulletins in English in the European and World Services radiated on short waves is given below. Times are BST.

0200:	49.10,	31.32,	30.53,	25.53.
0300:	49.10,	31.32,	30.53,	25.53.
0530:	49.10,	31.32,	30.53,	25.53.
0715:	49.10,	31.55,	25.53,	19.66, 19.60, 16.66.
0900:	49.59*,	41.49*,	40.98*,	31.55, 30.9*, 25.53, 25.29*, 19.82, 19.66, 19.60, 16.86, 16.84.
1200:	31.86,	19.82,	16.84,	16.77, 16.64, 13.97.
1400:	25.53,	19.82,	16.84,	16.77, 16.64, 13.97.
1700:	31.75,	31.55,	25.53,	19.82, 19.66, 16.84, 16.77.
1900:	31.55,	25.53,	19.82,	19.66, 16.84.
2145:	31.25,	25.53,	19.82,	19.60.
2215:	31.32,	31.25,	25.53,	19.82.
2300:	49.59*,	41.96*,	41.49*	
2345:	49.10,	31.32,	30.53,	25.53.

Wavelengths marked with an asterisk are used in the European Service only.

The B.B.C. has recently begun using the old Droitwich wavelength of 1,500 metres for the transmissions to Europe. Prior to the reintroduction of this wavelength by the B.B.C. the Icelandic station at Reykjavik (TFU) had, by arrangement with the British Government, been using it instead of its own wavelength of 1,442 m. in order to avoid interference.

AM.I.E.E.(W)?

REFERRING to the "increasingly diverse character of electrical engineering," *The Electrical Review* suggests that graduates of the Institution of Electrical Engineers "might be permitted to sit for an additional and optional 'honours' paper in the A.M.I.E.E. examination relating to the special subjects of one of the Institution's Sections. . . . Success would entitle them to put an appropriate letter in brackets, e.g. (T) for transmission, (I) for installation or (W) for wireless, after the other initials."

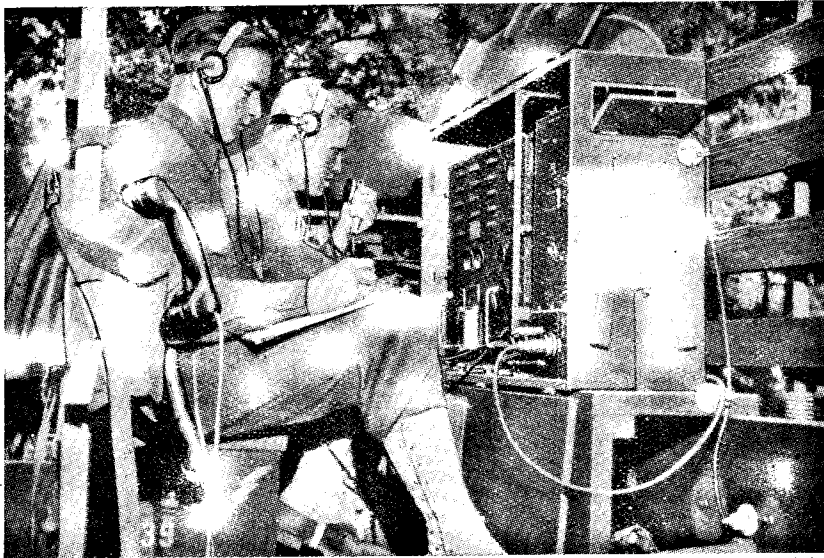

Courtesy "Life"

U.S. ARMY TRANSMITTER. Mounted in an army truck, it provides communication by CW, ICW and 'phone over the frequency range of 150-12,500 kc/s by the use of ten interchangeable tuning units. Five valves, consisting of a master oscillator, power amplifier, two modulators and a speech amplifier, are used in this 80-watt G.E. transmitter Type BC375. The first four valves are of the same type so that on CW operation the modulators are effective spares.

TELEVISION DEFINITION

Eliminating Reflection from Glass

A NEW chemical process to reduce extraneous reflections from glass has been discovered during research in R.C.A. Laboratories. Based upon "an important clue dropped by Lord Rayleigh in 1900," the process is applicable to any glass surface and withstands wear and climatic conditions. Subjecting the glass surface to hydrofluoric acid vapour, it is etched away, leaving a thin, transparent, purple film of calcium fluoride measuring approximately a quarter wavelength of light in thickness. Whereas ordinary glass has an average measured light transmission of approximately 90 per cent., the remaining 10 per cent. being lost through reflection, glass treated as described has a power of light transmission of 99 per cent.

The application of this method to cathode-ray tubes and mirrors in television receivers will do much to increase the definition of the image.

question of wavelength allocations was debated. "Papa" Rambert, of Switzerland, has a claim to have founded the Union, but his more lasting contribution to international radio is that his cordiality dispersed much misunderstanding and made the Union's work more effective.

Maurice Rambert was the Administrative Delegate to the Geneva Conference in April, 1925, at which the Union was formed, and he represented Switzerland at the first inter-governmental wavelength conference. He will be greatly missed at post-war conferences.

AMERICAN SUPERHETS

Circuit Refinements Sacrificed

AN indictment of the decline in the quality of American superhet receivers is made in a recent issue of the U.S. trade journal *Radio and Television Retailing*.

The writer states: "Sets now perform attractive extra functions, are easier to tune and styling apparently satisfies the mass market. But few

FROM ALL QUARTERS

Television Stations' Power

THE power of American television stations is not given by the F.C.C. in the conventional kilowatts, but as the "effective signal radiated." This figure, which runs into thousands, "equals the height of the aerial in feet, times the square root of the aerial input power in kilowatts, times the field gain of the aerial."

Delhi's Wavelengths

UNUSUAL atmospheric conditions necessitated the change of the frequencies used by the two Delhi short-wave transmitters VUD3 and VUD4 earlier than usual. The two frequencies now being used by VUD3 are 11.83 and 15.29 Mc/s and that by VUD4 9.59 Mc/s.

Canadian Receivers

MANUFACTURERS of receivers in Canada were recently notified that their output is to be 75 per cent. of that for 1940. The reduction will mean 123,000 fewer receivers.

Canadian Broadcasting Corporation

It is learned from the annual report of the Canadian Broadcasting Corporation that during the last fiscal year there was a net operating surplus of \$183,585. While commercial broadcasting brought in \$895,066, the income from licences was \$3,140,259.

Aerial Characteristics

AT the meeting of the Wireless Section of the I.E.E. to be held on Wednesday, January 7th, at 5 p.m., Mr. N. Wells, of Marconi's, will deliver his paper on Aerial Characteristics.

All-India Radio

ALTHOUGH it is difficult for All-India Radio to obtain equipment from Great Britain, we learn from the Chief Engineer that progress is being maintained and new projects planned. Among the projects are a 10-kW medium-wave transmitter for Peshawar, a 5-kW medium-wave station at Patna and a new centre at Karachi with a 250-watt transmitter.

B.S.I. Executive Committee

THE continued expansion of the work of the British Standards Institution has resulted in the appointment of an executive committee under a permanent chairman, which will keep all the activities of the Institution under review and report to the General Council. Mr. C. le Maistre, C.B.E., who has been connected with the movement almost since its initiation and who for the past 25 years has been its chief executive officer, has been appointed full-time chairman of the committee, and Mr. P. Good, C.B.E., for several years deputy director and recently joint-director, has been appointed director and secretary of the Institution.

Latin-American Service

FOR the purpose of transmitting the programmes of the Mutual Broadcasting System to Latin America, the U.S. Federal Communications Commission has authorised Press Wireless Inc.—the Press radio communication company—to radiate programme material to Central and South America. It is believed that this is the first time that a Press radiotelegraphic concern has been permitted to operate a programme service. The Los Angeles station of Press Wireless has been granted new frequencies and permitted to use some of its existing frequencies for broadcasting.

Retail Trade

RADIO receivers, gramophones and accessories are among the 48 categories of goods covered by the recent Board of Trade Order prohibiting the opening of new retail shops for the sale of such goods. Traders who have lost their premises as a result of enemy action may apply to the local Price Regulation Committee for a licence to open new premises.

Latin-American Network

THE National Broadcasting Company's Latin-American network was officially opened in October. Programmes broadcast from the short-wave stations WRCA and WNBI will be picked up and relayed by 92 short- and medium-wave stations in Central and South America.

Brit. I.R.E.

AT the last meeting of the Council of the British Institution of Radio Engineers, Mr. H. Leslie McMichael was elected vice-president. "Recent developments in the design and application of the cathode-ray oscillograph" is the subject of the paper to be given by Dr. W. Wilson at the meeting of the Institution at 3 p.m. on January 12th at 21, Tothill Street, Westminster, S.W.1.

B.I. Cables

HAVING, by arrangement, resigned his position as chief research engineer of Ferranti's, Dr. J. L. Miller is joining British Insulated Cables as deputy chief engineer. It is understood that Mr. F. Warburton Taylor, who has been with Ferranti nineteen years, is promoted to succeed Dr. Miller.

Early Birds

AMERICAN stations were recently granted permission to start broadcasting at 4 a.m. instead of 6 a.m.

NEWS IN ENGLISH FROM ABROAD

REGULAR SHORT-WAVE TRANSMISSIONS

Country : Station	Mc/s	Metres	Daily Bulletins (BST)	Country : Station	Mc/s	Metres	Daily Bulletins (BST)
America				India			
WNBI (Bound Brook)	15.130	19.83	2.15, 3.0†, 4.0†, 6.0†	VUD4 (Delhi)	9.590	31.28	9.0 a.m., 1.30, 4.50, 6.15.
WRCA (Bound Brook)	17.780	16.87	2.15, 3.0†, 4.0†, 6.0†	VUD3	11.830	25.36	1.30.
WGEO (Schenectady)	9.530	31.48	9.0†, 10.55§†	VUD3	15.290	19.62	9.0 a.m.
WGEA (Schenectady)	15.330	19.57	7.45§†, 9.55§†	Sweden			
WBOS (Hull)	11.870	25.27	5.0, 9.0, 12.0 midt.	SBO (Motala)	6.065	49.46	10.20.
WCAB (Philadelphia)	6.060	49.50	2.55 a.m., 6.0 a.m.	Turkey			
WCBX (Wayne)	11.830	25.36	7.30†, 8.15†, 8.45§†, 11 30.	TAP (Ankara)	9.465	31.70	8.15.
WCBX	15.270	19.65	2.0, 5.0§†	TAQ	15.195	19.74	1.15.
WRUL (Boston)	6.040	49.67	11.30§†	U.S.S.R. (Moscow)			
WRUL	11.730	25.58	11.30§†	31-metre band	—	—	7.0, 8.0, 9.0, 10.15
WRUL	11.790	25.45	8.30*, 9.30§†	Vatican City			
WRUL	15.350	19.54	4.0* 6.7§†, 8.30*, 9.30§†	HVJ	6.190	48.47	8.15.
WRUL	17.750	16.90	4.0*, 6.7§†				
WLWO (Cincinnati) ..	15.250	19.67	5.0†, 8.0†				
Australia							
VLR7 (Lyndhurst) ..	11.840	25.34	5.20.				
Egypt							
SUX (Cairo)	7.865	38.14	6.50, 10.10.				
French Equatorial Africa							
FZI (Brazzaville) ..	11.970	25.06	8.45.				

MEDIUM-WAVE TRANSMISSIONS

Country	Station	kc/s	Metres	Daily Bulletins
Ireland	Radio Eireann ..	565	531	1.40†, 6.45†, 6.50†, 10.0.

It should be noted that the times are BST—one hour ahead of GMT—and are p.m. unless otherwise stated. The times of the transmission of news in English in the B.B.C. Short-wave Service are given on the opposite page.
 * Saturdays only. § Saturdays excepted. † Sundays only. ‡ Sundays excepted.

LETTERS to the EDITOR

*The Editor Does Not Necessarily Endorse the
Opinions of His Correspondents*

Training of Wireless Engineers

THE National Certificate in Radio, which was first proposed by the Brit. I.R.E. in 1935, is quite good, but where are the entrants to come from? For some time one has read of "Short Courses for Radio Engineers" and similar nonsense. As a teacher of radio, may I suggest that the present system does give us a few folk who can at least call themselves "Radio Engineers."

A real radio course must always be prefaced by three years' simple electrical engineering:—1st year, DC; 2nd year, machines; 3rd year, AC. After this, the normal student takes a two-year heavy electricity course and takes his National Certificate. Such a man can then call himself a Certified Electrical and Radio Engineer!

If a man takes up radio, the first three years must be followed by at least three years on thermionics; 4th year, simple valve action and circuits; 5th year, detailed treatment of amplifiers and receivers; 6th year, detailed treatment of transmitter and other high-powered circuits. These years must be followed by a few more years on: 7th year, propagation and aerials, voltage limiting and control apparatus, filters, hybrids and wired wireless; 8th year, qualitative and quantitative measurements, including cathode-ray and associated apparatus; 9th year, television, electronics or other specialised subjects.

Such a course would not be complete unless it were supplemented by a knowledge of: acoustics, astronomy, chemistry, heat, mathematics and optics to a standard higher than the present B.Sc. (London) standard. Today, radio seems to be linking every other science, and, in fairness to the student, it appears that examinations should permit the use of any textbooks that the student wishes to consult in the limited time of the examination. This is merely using his tools (books) to the best advantage.

The present examination, which requires the memorising of strings of mathematical formulæ (many of which have very little or no use) is rapidly becoming ludicrous. This, with the wide scope of the subject, enables the electrical engineer to be humorous when he gets the radio man off his own special subject.

When designing a syllabus for a few years ahead one must always remember that to-day's specialised knowledge is to-morrow's general information. Consequently, radio courses which were very fine for 1925 will be of little use for 1942. At the same time, an even more serious point is the "when" of the courses. Radio men are always working during the winter nights, so classes must be run during the summer.

The last important point is "Teachers" for radio. An electrical engineer, no matter how good, cannot teach radio. At the same time, there are few radio engineers who can teach the required scope, all the best men being required to specialise. Men of the type of Colebrook, Scroggie and Sowerby and other contributors to *Wireless World* should be well qualified for the job of educating the young engineer.

This is a long letter, but there are a few outstanding points which should be brought to the notice of the authorities, who persist in regarding a radio engineer as merely a lower-grade electrician, or an offshoot of the Electrical Engineering Department. In practice, the radio man could eat the electrical engineer's subject and then carry on with his own.

W. M. DALTON.

Swindon, Wilts.

Conditions for Amateur Licences

I HAVE followed with great interest the discussion in your columns on Morse versus Technical Ability with regard to the future granting of amateur radio licences. But, and this is the point I wish to make in this letter, correspondents have taken it for granted that conditions will return to the pre-war state of affairs, the crowded amateur bands, the unearthly jargon which was slung across them, and the contact-making for the sake of contact-making. In short, 40-metre Sundays.

Is it not likely that, now the governments of the world have realised the utility of short waves, the amateurs will be pushed down to lower wavelengths, thus enabling the space they previously occupied to be devoted to official or commercial communication? After all, this has been happening since the earliest days of amateur radio.

If this does happen, where will the amateurs find themselves? Is not the logical answer, on microwaves? This portion of the radio-frequency spectrum, i.e., between one metre and infra-red, is only just beginning to be explored. The centimetre waves are not yet thoroughly understood, but their uses are known to be numerous.

The equipment necessary, though specialised, is not so elaborate as on lower frequencies. These microwaves cover a region where careful adjustment, patience, and efficiency of operation (qualities characteristic of the true amateur) mean more than mere watts dissipated. I would suggest that this is the band of the future, this little-known and little-explored region of 300 Mc/s upwards. What a challenge to the amateur!

I therefore think that it would be found more fruitful if your correspondents were to devote a little time, thought, and space to this matter, rather than quibbling as to whether or not morse is necessary.

PETER DEAN,
BR54295.

Prestwich, Lancs.

Physiological Effects of USW Radiation

"CENTIMETRE," in the November, issue, says that someone ought to make an immediate investigation. I think it probable that a great deal of investigation is going on in this connection, though possibly not in the form of organised research.

Ultra-high frequencies are used to a limited extent by the medical profession (radio-therapy), and a Russian scientist, Lakhovsky, has designed an oscillator covering a wide range of frequencies extending into the range of infra-red radiation, which he has used for the cure of a number of diseases, most of his work being on cancer.

Lakhovsky infers the danger of certain frequencies in his rejection of an original oscillator capable of exciting the cells of the body directly. He found deleterious results often accompanied the use of his "cellulo-oscillator." That the cells act as miniature receivers by virtue of their associated inductance and capacity is a theory of Lakhovsky's which will be criticised in many quarters, but I believe that biological science will eventually accept it.

Lakhovsky's papers, read before the *Academie des Sciences* (in pre-war days) were sponsored by Prof. D'Arsonval, and possibly we could obtain more information from France and the U.S.S.R.

Treorchy, W. H. WALKER.
Glam. zDXS.

DC Valve Voltmeter

A Low-range Instrument of High Input Resistance

IT frequently occurs in the designing or testing of wireless apparatus that a knowledge of the value of the steady potential which exists between two points is desirable—or even essential. The best voltmeter of ordinary design does not give an exact indication of the true voltage between those points, for it inevitably imposes a load on the circuit to which it is connected. In many cases this is not important, since the error is small when the resistance of the voltmeter is high compared with the resistance of the circuit across which it is connected. Even when this is not so, however, it is often possible to apply corrections and so obtain the true figure for the voltage.

There is, however, one class of measurement for which this course is not open. It is often necessary to know the steady potential developed across the load resistance of a detector, particularly in the case of a detector which is used for automatic volume control purposes. The resistance across which the potential to be measured is developed as a result of the rectification of a signal is usually of high value, and 2 megohms is not an uncommon figure. The voltage may vary over a wide range, from, say, 0.5 volt to 15 volts or more. If a true reading of voltage is to be obtained, the voltmeter must have an internal resistance certainly not less than 20 megohms, so that if we choose an instrument with a maximum scale reading of 10 volts, it must be rated at the imposing figure of at least 200,000 ohms per volt—which is probably quite unattainable. It should be remarked that for the case under consideration, namely, the measurement of rectified voltage, it is not possible to use a low-resistance instrument and to apply a correction factor, for the reduced load on the rectifier will not only affect the efficiency of rectification, but will also lower the input impedance of the detector, and so modify the effective RF resistance of the tuned circuit from which it is fed. This, in turn, will affect the amplification and selectivity of the receiver, particularly if appreciable regeneration exists. Any correction factor, therefore, would be impossibly complex.

There are two alternative methods which can be used besides the one which it is the purpose of this article to describe. The first of these is the electrostatic voltmeter. This fails,

however, on the grounds that it is difficult to obtain an instrument which will read accurately voltages lower than some 25 volts, while its scale is very far from linear, and is particularly cramped at low voltages. The second method is the most widely used and is accurate. It consists merely in measuring the current through the circuit with a microammeter, and the voltage across it can, of course, be immediately calculated if its resistance be known. Where only a few readings must be taken, there is little objection to this method, but it has several disadvantages in experimental work. The values of resistance commonly met with in the load circuit of diode rectifiers lie between some 2 megohms and 100,000 ohms, while the range of potentials developed across them is not likely to be less than 0.5–15 volts. The currents involved, therefore, will vary from 0.25 microampere to 150 microamperes (μA). Several meters are likely to be needed, and those for the lower ranges are likely to be sluggish or to have poor damping. Moreover, they will be expensive and easily damaged by the misconnections which inevitably occur in experimental work.

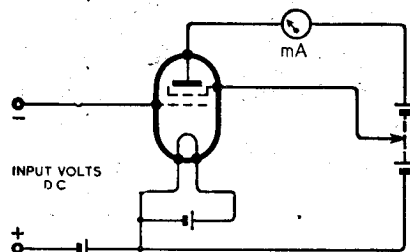

Fig. 1. Basic circuit diagram of a valve voltmeter of which the range of anode current proved too wide.

It seemed to the writer that the problem would best be solved by the use of a form of valve voltmeter with which a robust instrument, such as a low-range milliammeter, could be used. It was desired to construct a meter which could be employed over a wide range of voltages greater than some 0.5 volt, but the exact upper limit was unimportant provided that it was not less than about 15 volts. The ideal scale appeared to be logarithmic, for then the percentage accuracy with which the meter could be read would be the same over the whole scale; the use of a variable-mu

type valve accordingly suggested itself. The arrangement of Fig. 1 was set up, but it did not prove satisfactory, nor did several modifications of it, for the reason that the ratio of maximum to minimum current was too great for a single range indicating instrument.

Excessive Current Range

It can be seen that with no input voltage, the anode current of the valve is at maximum, lying between some 2 mA to 5 mA according to the valve selected and the voltage applied to it. When an input voltage is applied the anode current falls by an amount which depends upon the value of this voltage, since its polarity must be such that the grid of the valve becomes more negative than before with respect to its cathode, in order to avoid grid current and to maintain a high input resistance. It was found that with all the valves tried the anode current fell below 10 μA for input potentials less than 15 volts.

Now an inexpensive meter with a maximum scale reading of 5 mA cannot usually be read accurately to less than 50 μA , so that this would obviously be very unsuitable. A meter with a maximum reading of 1 mA was available; this had a scale of 20 μA per division, and could easily be read to 10 μA , and, with care, to less. It was decided, therefore, to employ this meter and to adjust the circuit so that the anode current was 1 mA with no input and fell to not less than 10 μA for an input of some 15 volts or more. For given battery potentials the current through the meter depends on the internal resistance of the valve, which varies according to the voltage applied to its grid. The valve, therefore, was required to have such a resistance with no input that it passed a current of 1 mA, and with an input of 15 volts, 10 μA . It was considered desirable to use an initial bias of -1.5 volts in order to avoid any risk of grid current when measuring small voltages, so that the above current consideration had to be fulfilled for biases of -1.5 and -16.5 volts respectively.

All the screen-grid valves tried were found to pass a smaller current than 10 μA at a bias of -16.5 volts with anode voltages up to 120 volts, and a higher voltage supply was considered undesirable, although there is, of

D.C. Valve Voltmeter—course, no technical objection to it. The only valves which could be found to give a suitable current were triodes of the small power class, and it was obvious that at -1.5 volts bias the internal resistance would be so low that the current would greatly exceed 1 mA; 20 mA to 40 mA was a more

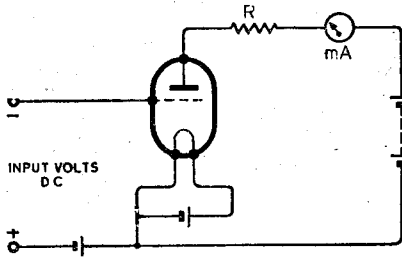

Fig. 2. Triode voltmeter with limiting resistance.

likely figure. The difficulty was overcome by inserting a limiting resistance in the anode circuit as shown in Fig. 2, for this reduces the variation of the total circuit resistance. Speaking very roughly, the valve and its anode voltage were chosen so that at -16.5 volts bias the anode current was $10 \mu\text{A}$ and the resistance R was selected to pass 1 mA when connected across the HT battery. This, of course, assumes that the valve resistance is negligible compared with R with no input, and that R is small compared with the valve resistance at full input, which is obviously not true, but well illustrates the principle.

Preliminary tests showed that this arrangement completely solved the difficulties and the final model was built to the circuit diagram of Fig. 3. With the values of components selected the meter reads to rather more than 15 volts and a current of $10 \mu\text{A}$ is obtained with an input of 0.1 volt. With no input the meter reads zero, for the valve anode current of 1 mA is backed off by the connection of R_2 to the LT battery.

A two-volt battery-type valve was selected, actually the Osram P2, and it is operated from a 2-volt accumulator. No provision has been made for compensating variations in voltage, for an accumulator in good condition, and neither freshly charged nor

nearly run down, can be relied upon for a very steady output. The backing-off resistance R_2 must pass a current of 1 mA through the meter, which has a resistance of about 100 ohms. The value of R_2 , therefore, should be $1,900$ ohms, but a standard resistor of $2,000$ ohms value is employed. The resistance used is not specially picked, so that the backing-off current may differ appreciably from 1 mA. This is unimportant, however, for the initial operating conditions are adjusted, not for an anode current of 1 mA, but for an anode current which exactly equals the backing-off current, and so brings the meter reading to zero. If the current is not exactly 1 mA, of course, the length of scale available may be restricted, as this occurs to a small degree in this model.

Provision is made for adjusting the anode voltage by means of the potentiometer R_3 - R_4 connected across the HT battery, the adjustable element R_4 having a value of $10,000$ ohms, and the fixed portion R_3 a value of $75,000$ ohms. The 120 -volt HT battery is built into the instrument, and when new is used on the 108 -volt tapping, with which the slider of R_4 is set at about one-half

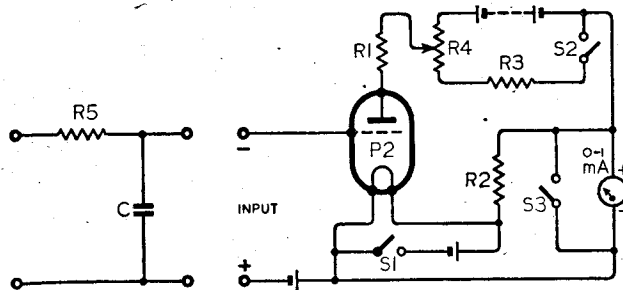

Fig. 3. Final circuit arrangement of the valve voltmeter described.

its travel. There is thus ample latitude for the compensation of falling battery voltages. The limiting resistance R_1 has a value of $75,000$ ohms.

A double-pole make-and-break switch is included to break the LT circuit (S_1) and to disconnect the poten-

tiometer from the HT battery (S_2) when not in use. It was found advisable to include also a switch (S_3) to short-circuit the meter when switching on or off. Without such a switch the meter jumps to full-scale reading when the instrument is switched on, because the backing-off current flows immediately, whereas the valve anode current takes some seconds to reach its full value on account of the thermal lag in the filament. Similarly, when it is switched off, the needle tries to indicate 1 mA in the opposite direction and only succeeds in pressing against the stop to the left of zero, be-

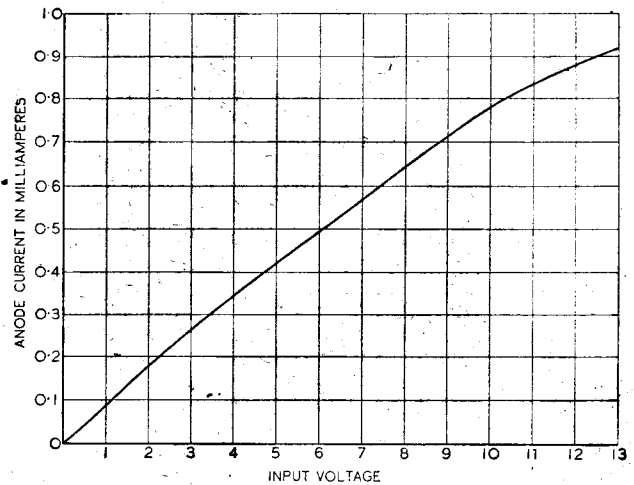

Fig. 4. Calibration curve of the original model of the meter described in this article.

cause the anode current persists longer than the backing-off current. The switch S_3 , which is kept closed except when actually using the instrument, is therefore included.

The calibration curve of the original model is shown in Fig. 4 and will be seen to be nearly linear for inputs up to some 10 volts. This is, of course, due to the fact that up to 10 volts the operation is over the straightest part of the valve characteristic. An important result of this is that the reading of the meter is unlikely to be affected by the presence of an AC ripple on the steady potential which is to be measured. In many applications of the instrument, such as the measurement of AVC potentials in certain parts of a receiver, an appreciable ripple will be present and its peak value may equal or exceed the steady voltage. In such cases it is not safe to rely on the linearity of the meter, and a filter for insertion between the voltage source and the meter is then advisable. This filter is shown as a separate unit on the left-hand side of Fig. 3; it consists simply of a 2-megohm resistance R_5

and a 0.1 μ F condenser C, values which give effective filtering not only at radio frequencies, but also at quite low audio frequencies. The time constant of this filter is appreciable (0.2 second), so that the meter becomes somewhat sluggish when the filter is included, but not unduly so. It may be remarked that the condenser used must have very high insulation resistance, otherwise it will form a potentiometer with R_5 to direct current, and the calibration of the meter will be affected. A mica dielectric component was therefore chosen. It should also be pointed out that when the meter is used in a circuit containing AC as well as DC, its connection may affect the circuit conditions. The input resistance of the meter to direct current is merely the insulation resistance of the input components, but to AC the impedance may be low.

Audio and Radio Frequencies

Considering the meter alone, there is first the input capacity, which is undoubtedly large enough to have an effect at radio frequencies, and there is the Miller effect in the valve to be considered at both radio and audio frequencies. When the filter is included the Miller effect is absent and the input capacity is then merely the input capacity of the filter. The condenser C will often be of negligibly small reactance, however, so that as far as AC is concerned the resistance R_5 of 2 megohms is effectively in shunt with the input. These effects are not of great importance in the normal application of the apparatus.

Among the uses to which the meter has already been put, and for which it has proved invaluable, may be mentioned the measurement of detector output, AVC voltages, and true grid bias. AVC voltage can be measured not only across the diode load resistance, as when a microammeter is employed, but actually at the grid of the controlled valve in many cases. In any case, where the grid circuit of a valve contains a high resistance, the measurement of the true grid potential is difficult by ordinary means.

Apart altogether from its uses in such circuits, it may be employed in the measurement of the insulation resistance of condensers. If a source of voltage be connected through a known resistance of suitable value to the input terminals, a certain deflection corresponding to that voltage will be obtained. If now the components to be measured be connected across the input terminals, the reading will be lower. Suppose, for example, that we

apply 10 volts through a 2-megohm resistance, the meter will read 0.78 mA. If we now shunt the input by a resistance of 20 megohms, the voltage will drop to $\frac{10 \times 20}{22} = 9.1$ volts, and the

meter will read 0.718 mA, a very noticeable change. The input resistance of the meter can be measured in a similar way, and if the filter is to be used it is advisable to do this, so that a correction factor can be found should the input resistance prove low enough to necessitate this.

The simplest method of measuring the input resistance is to apply a voltage E_1 to the input terminals. Then insert a high resistance R_1 in series with the lead to the negative input terminal and read off the new value of input voltage on the meter itself. Calling this E_2 , we have $E_2 = E_1 R / (R + R_1)$ where R is the input resistance, so that $R = R_1 / (E_1 / E_2 - 1)$. The greatest accuracy is, of course, obtained when R_1 is of the same order as R . When the input resistance is known, the correction necessary in cases where the voltage to be measured is necessarily fed to the voltmeter through a high resistance, as in certain AVC circuits, can readily be calculated. Writing R_1 for the series resistance, it is $(R + R_1) / R$; that is, the meter reading in voltage must be multiplied by this factor. The input resistance of the experimental model was too high to be determined accurately in this way, being over 100 megohms, and so is negligible.

Similarly, when the filter circuit already mentioned is employed, a similar correction factor can be obtained. The effective input resistance of the meter is now the true resistance in parallel with the resistance of the condenser. Calling this figure R' , it can be measured as before by connecting a known voltage to the meter itself, leaving the filter connected and its input terminals open-circuited, and then changing the source of voltage to the input of the filter. The input resistance of the meter is then $R' = R_5 / (E_1 / E_2 - 1)$ and the input resistance of the filter $R_5 + R'$. The correction factor becomes $(R' + R_5) / R'$.

GOODS FOR EXPORT

The fact that goods made of raw materials in short supply owing to war conditions are advertised in this journal should not be taken as an indication that they are necessarily available for export.

The "Fluxite Quins" at work

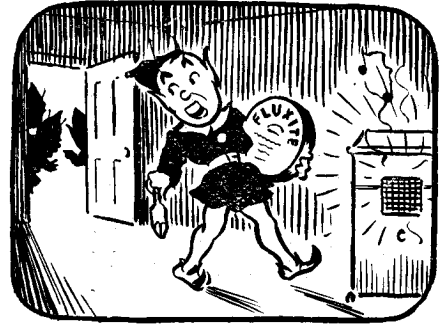

"We're not coming in, that's a cert."
Yelled EE "Why there goes the alert."
Said Oi "Now don't fret
It's a wailing old set
just needs FLUXITE—I'll wager my shirt."

See that FLUXITE is always by you—in the house—garage—workshop—wherever speedy soldering is needed. Used for 30 years in Government works and by leading engineers and manufacturers. Of Ironmongers—in tins, 4d., 8d., 1/4 and 2/8.

Ask to see the FLUXITE SMALL-SPACE SOLDERING SET—compact but substantial—complete with full instructions, 7/6.

Write for Free Book on the art of "soft" soldering and ask for Leaflet on CASE-HARDENING STEEL and TEMPERING TOOLS with FLUXITE.

TO CYCLISTS! Your wheels will NOT keep round and true unless the spokes are tied with fine wire at the crossings AND SOLDERED. This makes a much stronger wheel. It's simple—with FLUXITE—but IMPORTANT.

THE FLUXITE GUN

is always ready to put Fluxite on the soldering job instantly. A little pressure places the right quantity on the right spot and one charging lasts for ages. Price 1/6, or filled 2/6.

FLUXITE LTD.
(Dept. W.W.),
BERMONDSEY
STREET E 1

ALL MECHANICS WILL HAVE

FLUXITE

IT SIMPLIFIES ALL SOLDERING

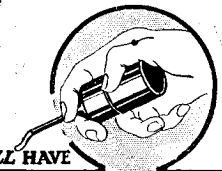

UNBIASED

Secret Wireless Weapon

LIKE a good many other people I have always been attracted by the unusual and the extraordinary, and as a boy always made a bee-line for the tent of the tattooed lady and the two-necked giraffe whenever a circus visited my home town, and it is not surprising, therefore, that when browsing among the contents of the railway bookstall the other day in order to choose some literature to beguile the tedium of an impending journey, my eye spotted a newly published book with the rather unusual title of "The Behaviour of Slow Electrons in Gases."¹ Frankly, the slow electron was a complete stranger to me, and I could only suppose it to be some odd freak of nature like heavy water and the square circle.



Tent of the Tattooed Lady.

As my journey through the countryside and the pages of the book proceeded, my excitement mounted to fever heat, until it reached its climax when I arrived at a section of the book telling about the behaviour of the ionosphere under the influence of wireless waves. No doubt some of the more stodgy and less imaginative among you will think, as did one of the Editor's myrmidons who was travelling with me, that as wireless men you are far more interested in the effect of the ionosphere on the radio waves and don't care a brass farthing about the effect of the ether waves on the ionosphere; and as for the behaviour of electrons, you don't care a fig so long as they behave themselves when inside your sets.

It is, of course, just this sort of narrow parochial outlook which is responsible for so many of our troubles. So far from being unimportant, the effect of the ether waves

¹ "The Behaviour of Slow Electrons in Gases," R. H. Healey and S. W. Reed, distributed in this country by *The Wireless Engineer*.

By FREE GRID

on the ionosphere is just about the most important thing in the world at the moment, as what the book had to tell me on this matter confirmed some information which I had recently received concerning certain radio research activities being carried out by the enemy.

Put briefly, and in non-scientific language for the benefit of those of you who have only recently joined the ranks of *Wireless World* readers, my information, which this book tends to confirm, is that Adolf's research wallahs have been working on the hypothesis that the effect of an intense concentration of wireless waves on the ionosphere is to knock holes in it. I am perfectly well aware that the holes are self-sealing just like those made in water by dropping stones in it, but if the etheric barrage is kept up the holes don't get a chance to fill up any more than do those in the water if you keep up a constant barrage of stones.

Now this may all seem very academic and unimportant to you at first sight, but Adolf is not the sort of man to let his scientists waste their time in research into this matter unless there is something tangible to be got out of it, and there is, I am convinced, some method in his apparent madness of sticking up huge "radio guns"—or, in other words, strongly directed U-S-W transmitters—in the lonely wastes of East Prussia, guns which are intended to fire concentrated beams of apparently harmless wireless waves at the ionosphere.

His object is, of course, to bide his time until the dawning of *Der Tag* when he makes his great onslaught upon us. He will then be able, by riddling the ionosphere with holes and keeping it riddled, to cut our wireless communications entirely, as all the signals sent up from our far-flung battle line will pass harmlessly through the ionosphere into outer space instead of being reflected back as usual. The result will be that, with the exception of the short-range direct ray, our wireless stations will be effectively silenced.

Of course, it may be argued that in this manner he will cut his own wireless communications, but this won't matter a tinker's cuss as he will be prepared for it, and will have alternative systems of communication ready, whereas we certainly shall not

unless I can succeed in rousing some of those in a position to do something to a proper appreciation of this impending danger.

Into the Future

ALTHOUGH this is the January issue of *Wireless World*, such is the topsy-turvy condition of the world to-day that it will actually be in your hands a few days before Christmas, like any low lay journal of pre-war vintage which appeared before its publication date. I must, therefore, take this opportunity of tendering you the compliments of the season. Those of you who are accustomed to celebrate Hogmanay or go "first-footing" on the stroke of midnight on December 31st, I would remind that you will this year once again have to wait until 1 a.m., as the clock is an hour ahead of its schedule, and the new year begins by strict GMT.

Being on the threshold of a New Year, it is a convenient time to remind you that we must begin to think about getting ready for the Peace and Victory number of *Wireless World*. This does not, unfortunately, necessarily mean that it is likely to be published in the near future, in spite of the fact that certain star-gazers have named January 31st as Adolf's day of doom. After all, many people, as soon as a child is born, begin to get ready for an event which may not take place for another three-score years and ten by taking out an insurance policy on the child's life. Therefore, lest I should be accused of raising up false hopes, I am publishing a little sketch herewith showing what may well be my own humble part in

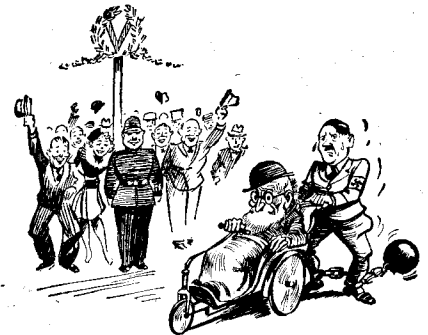

Peace Procession 19??

the great peace procession. No doubt many of you will, by estimating my age, be able to form some opinion of the probable date of the procession. Don't forget, however, that there are other things apart from mere age which put years on you.

An "All-dry" Portable

Further Notes on the Design of a "Personal" Headphone Set

By S. W. AMOS, B.Sc. (Hons.)

IN an article in the August issue of this year¹ the author mentioned the possibility of using two valves of the 1.4 volt filament type in a det.-LF circuit for a portable receiver to operate 'phones. The attraction of this new type of valve lies, of course, in the fact that their filaments are designed to operate satisfactorily from a single dry cell. It is thus feasible to construct a very compact portable using these valves, deriving its HT from a single GB battery and its LT also from dry cells.

two valves can be connected in parallel and energised from a single dry cell, in which case the LT current is 0.2 amp, or else a series connection can be adopted, as in the accompanying diagram. The current is then 0.1 amp and a 3-volt LT supply is required. The author is of the opinion that the latter alternative is preferable, since twin-cell batteries of the type used in cycle lamps can then be used for LT supply. These, as night cyclists will know, give good service when supplying the 0.3 amp demanded by the

average 2.5-volt torch bulb, and so should prove excellent when the drain is a modest 0.1 amp. Also—and this is quite a considera-

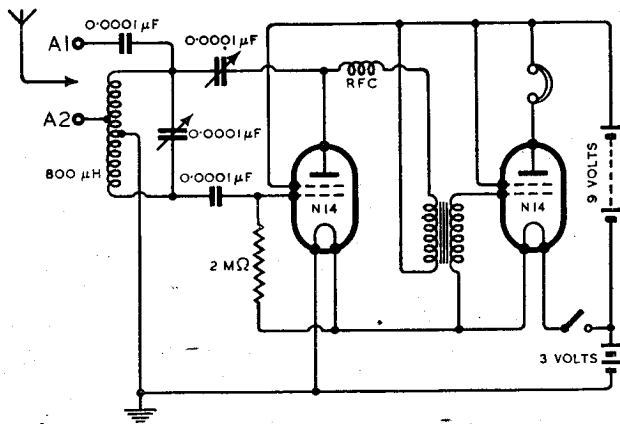

Circuit diagram of a light-weight portable using two 1.4-volt tetrodes as detector and AF amplifier instead of the 2-volt valves originally specified.

For satisfactory operation at low anode voltages valves should have a low impedance. For this reason the P220 type originally recommended was particularly suitable. It is somewhat unfortunate that the new range of 1.4-volt valves does not include a type quite similar in characteristics to the P220, but experiments have shown that output tetrodes of the N14 type make excellent detectors with 9 volts HT, using the same Hartley circuit as before, which, for convenience, is reproduced herewith, but with tetrodes in place of the original triodes. Tetrodes can, of course, easily be converted into triodes of fairly low impedance by bonding the anode to the auxiliary grid, but experiments have shown that their performance in this particular circuit is slightly superior when connected as tetrodes.

tion in these days—they are comparatively easy to obtain.

Save Paper

EVERYONE should know by now that it is an obligation of every citizen to collect waste paper for salvage. The increased demands on our shipping, consequent on the outbreak of war in the Pacific, has lent extra force to the Ministry of Supply's appeal. What is not so widely realised is that efficiency in the handling of wartime salvage is often of vital importance; waste of man-power may be even more culpable than waste of material. For instance, a few extra minutes' voluntary work on the part of collectors may save much more time when the waste paper comes to be sorted. Greasy paper is a nuisance, and should not be sent. The work of sorting will be facilitated if similar kinds of paper—newsprint, periodicals, books, general waste, etc., are kept in separate bundles or packages.

¹ "Designing Small Portables," p. 206, *The Wireless World*, August, 1941.

VORTEXION

50w. AMPLIFIER CHASSIS

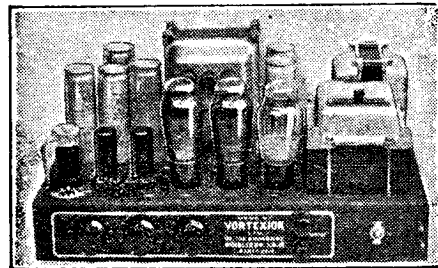

A pair of matched 6L6's with 10 per cent. negative feed-back is fitted in the output stage, and the separate HT supplies to the anode and screen have better than 4 per cent. regulation, while a separate rectifier provides bias.

The 6L6's are driven by a 6F6 triode connected through a driver transformer incorporating feed-back. This is preceded by a 6N7 electronic mixing for pick-up and microphone. The additional 6E5 operating as first stage on microphone only is suitable for any microphone. A tone control is fitted and the large eight-section output transformer is available in three types—2.8-15-30 ohms; 4-15-30-60 ohms or 15-60-125-250 ohms. These output lines can be matched using all sections of windings and will deliver the full response (40-18,000 c/s) to the loud speakers with extremely low overall harmonic distortion.

- CHASSIS with valves and plugs £17 10 0
- Moving Coil Microphones £5 5 0
- Chromium Microphone Stands from £1 5 0

Many hundreds already in use

15w. AC & 12-VOLT DC AMPLIFIER

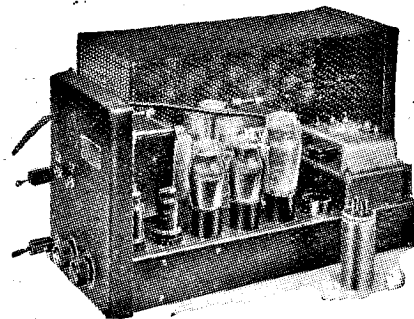

TYPE CP20

This small Portable Amplifier operating either from AC mains or 12-volt battery, was tested by "THE WIRELESS WORLD," October 1st, 1937, and has proved so popular that at Customers' demand it remains unaltered except that the output has been increased to 17.2 watts and the battery consumption lowered to 6 amperes. Read what "The Wireless World" said:—

"During tests an output of 14.7 watts was obtained without any trace of distortion so that the rating of 15 watts is quite justified. The measured response shows an upper limit of 18,000 c/s and a lower of 30 c/s. Its performance is exceptionally good. Another outstanding feature is its exceptionally low hum level when AC operated even without an earth connection. In order to obtain the maximum undistorted output, an input to the microphone jack of 0.037 volt was required. The two independent volume controls enable one to adjust the gain of the amplifier for the same power output from both sources, as well as superimpose one on the other or fade out one and bring the other up to full volume. The secondary of the output transformer is tapped for loud speakers or line impedances of 4, 7.5 and 15 ohms." Prices

- AC and 12-volt CHASSIS with valves, etc. £12 12 0
- AC only CHASSIS with valves, etc. £8 18 6

Gauge Case for either chassis, 12/6 extra.

Plus 20% War Increase.

Orders can only be accepted against Government Contracts.

Vortexion Ltd., 257, The Broadway, Wimbledon, S.W.19. 'Phone: LIBerty 2814

RANDOM RADIATIONS

By "DIALLIST"

The Mild Brain Teaser

LOTS of readers sent in solutions of the mild brain-teasing problem that I mentioned last month in these notes. Most of them produced correct solutions, though one or two who began their letters by scornful remarks about the easiness of the question didn't manage to find the answer? Here it is, in case you'd like it. The problem, if you remember, was this: a pentode, of which the anode current is constant at 6mA at all anode voltages above 60, receives its anode voltage from the slider of a potentiometer of which the windings, connected across a 240-volt DC supply, have a total resistance of 60,000 ohms. The anode potential is 180 volts; what is the resistance of the potentiometer windings between the slider and earth? As the anode current is 6mA the anode-cathode resistance of the valve must be 30,000 ohms. Call the potentiometer resistance between slider and earth x . Then, working in thousands of ohms:—

$$\begin{aligned} \frac{60-x}{30+x} &= \frac{60}{180} = \frac{1}{3} \\ \therefore (60-x)(30+x) &= \frac{1}{3} \\ \therefore \frac{30x}{(60-x)(30+x)} &= \frac{3}{10x} \\ \therefore 1800-30x+60x-x^2 &= 10x \\ \therefore x^2-20x &= 1800 \\ \therefore (x-10)^2 &= 1800+100 \\ \therefore x-10 &= \sqrt{1900} \\ \therefore x &= \sqrt{1900+100} \\ &= \pm 43.588+10 \end{aligned}$$

The negative answer is obviously ruled out.

Hence $x=53.588$ thousand ohms, or 53,600 ohms to three figures.

Pretty Near

Now even if your maths are pretty good the thinking-out and working-out of the solution will take two or three minutes. It's a matter of thirty seconds for anyone—even poor ignoramuses like me, whose early education was of the classical and not the mathematical variety—to arrive at the rough answer that I gave last month of 54,000 ohms. The difference is 412 ohms, which in 60,000 is neither here nor there. Is the labour of finding the correct answer worth while? I find it hard to imagine any state of affairs in practice where it would be obvious if you wanted to substitute fixed resistances for the two parts

of the potentiometer (as in practice you would when designing a set) so as to make a potential divider, it would be a queer circuit in which the use of a resistance of 6,412 and another of 53,588 gave a markedly different performance from that of a pair of 6,000 ohms and 54,000 ohms respectively. Certainly the difference would not justify the employment of specially wound, and therefore expensive, resistors in place of a standard 6,000-ohm resistor in the top part and, in the bottom part, 50,000 ohms+4,000-ohm resistors.

Close Quarters

LATELY I've been stationed almost on the doorstep of one of the B.B.C.'s high-powered transmitting stations, and very impressive its slim, sky-scraping masts are as a feature of the landscape. I'm told, though I haven't had the time to go and verify it, that if you're passing near-by on a calm, quiet evening, when there are neither wind nor traffic noises, you can actually hear a somewhat distorted version of the broadcast programme coming from the masts themselves. Every bolt or strut with the slightest play in it is set vibrating, and strains of music are audible at quite respectable distances. It seems difficult to find a plausible explanation. Most of us, I expect, have had experience of what an audio-frequency transformer with the laminations of its core not tightly clamped up can do,

but the two cases are hardly parallel. I am living so near the station that it's not easy to prevent the ordinary broadcast receiver from being overloaded. Unless it's fairly well screened and has short grid leads, direct pick-up here and there can produce some queer effects.

Towards Sanity

FOR many years I've battled against the retention of the old conventional view of electric currents as flowing from positive to negative. It was an unfortunate guess, made long before the electron was so much as thought of, that gave us the ideas of current that after so many years of use crystallised into simple but entirely erroneous conventions. Still more unfortunately Lenz and others founded their Rules and Laws on these conventions. These were embodied in every textbook from the primer upwards, and were drilled into the heads of generations of pupils by science masters and lecturers at schools and universities. The first vacuum tubes foreshadowed the doom of the old positive current idea. The coming of the wireless valve (you just can't regard the current flow as being from anode to cathode in a valve) drove another nail into its coffin. The development of the cathode-ray tube put paid to it, or should have done so. However you may wangle the positive current to fit explanations of the valve as an amplifier or as a grid-leak-and-condenser detector, you'd be hard put to it to explain how a positive current flowed from the screen of a cathode-ray tube through the two or three anodes and the grid to the cathode.

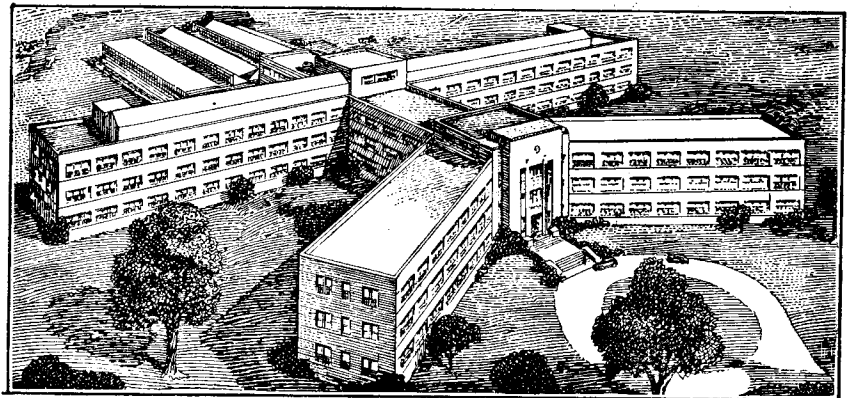

RESEARCH LABORATORIES and staffs which have hitherto been employed by different sections of the Radio Corporation of America group of companies will be brought together in these new buildings at Princeton, New Jersey, U.S.A. This reproduction from the architect's drawing gives some idea of the vastness of the buildings which are being erected on a 250-acre site for R.C.A. Laboratories.

One Way Out

One way out of the difficulty was, of course, to hedge, as some textbooks did, by saying that, though the current really flowed from negative to positive, it was convenient to regard it as doing the other thing except in certain circumstances. That was a Hibernian way of clearing the atmosphere by liberating generous doses of artificial fog. I could never see the value of teaching as basic truths things that are basically untruths. There's little point in drilling into a fellow's head the Right Hand Rule, and then telling him afterwards that it's all according to Cocker so long as he uses his left hand! I'm delighted to find that in the Services a start has been made along the right path. I don't think that in the Services the electron flow has yet ousted the positive-to-negative current everywhere; but it has certainly begun to do so, and the influence of their training may be sufficient to make us throw over the old mistaken and clumsy conception everywhere when peace returns. May it be so!

Valve Replacements

A Useful Manual for the Serviceman

IN the present circumstances, when it is often difficult to obtain the correct replacement for a faulty receiving valve, suggestions for the substitution of a near equivalent which will suffice to keep the set in service are of the greatest value. Often a valve of similar characteristics is available, but a small change in the base connections is necessary before it can be put to work.

A comprehensive survey of the valve position in relation to repair work has been made by Alan C. Farnell and Arthur Woffenden, and they have published their findings in the form of a manual which shows a clear appreciation of the serviceman's everyday troubles. There is an up-to-date list of American valves with their electrical characteristics and valve base connections, and this is followed by a replacement list giving substitutes and a cross-reference to later sections dealing in detail with specific cases where alterations to base connections may be required. There is also a fund of commonsense advice on the servicing of midget and other AC/DC receivers, the replacement of barretters, etc.

Copies of "The Valve Replacement Manual" are obtainable direct from A. C. Farnell, 49, St. Paul's Street, Leeds, 1, and the price is 5s.

COMMUNICATIONS DEPEND....

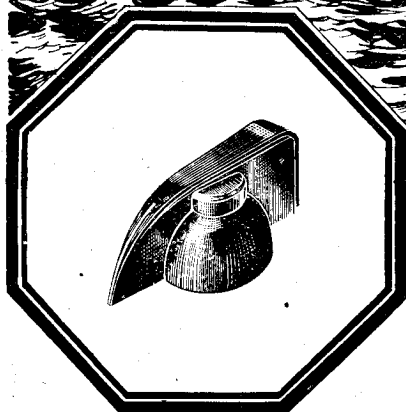

ON SMALL PARTS....

IN countless instances quite intricate pieces of apparatus are wholly dependent on the proved reputation and reliability of their component parts.

All products from the House of Bulgin are pre-eminent for superior design and workmanship, and every article bearing our Trade Mark has to pass exacting and exhaustive tests during the course of its production.

We ask the kind indulgence of the Trade on delivery until peaceful conditions return.

*The Choice
of Critics*

BULGIN FOR KNOBS

The largest and most extensive range in the world. Over fifty models from which to choose. All sizes and shapes, for different classes of work or operation. Nearly every type has brass-insert, steel grub-screws are fitted, well sunk. For 0.25in. dia. shafts and other sizes. Finely moulded and highly polished. The highest class Instruments use Bulgin Knobs exclusively.

ALWAYS DEPEND ON

BULGIN

REGISTERED • TRADE • MARK

A. F. BULGIN & CO. LTD., BY-PASS RD., BARKING, ESSEX.

Telephone: RIPPLEWAY 3474 (4 lines).

RECENT INVENTIONS

A Selection of the More Interesting Radio Developments

AMPLITUDE AND PHASE CONTROL

IN the circuit shown, a resistance in the cathode "leg" of each valve provides negative feedback, and a shunt impedance Z gives control of frequency or phase. If in a high-frequency amplifier the impedance Z comprises a resistance in series with a capacity, the positive feedback is such as to amplify the higher frequencies more than the low. If either the capacity or resistance is made variable, the circuit will serve as a tone control to increase the high-frequency response for strong signals in a low-frequency amplifier.

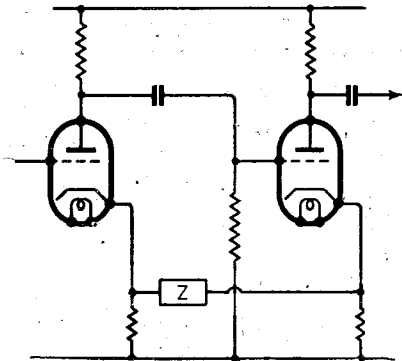

Cathode-impedance frequency control.

If, on the other hand, the impedance Z is made up of a resistance in series with an inductance, the amplifier will favour the lower frequencies instead of the higher.

As an alternative, the impedance Z may comprise a resistance in series with a parallel-tuned circuit. This can be used as a whistle filter, or for attenuating the so-called image signal on a superhet; or it will serve to attenuate adjacent-channel interference. If the parallel circuit is replaced by a series-tuned one, the amplification favours the resonant frequency, and can be used, for instance, in homodyne reception, or for single-frequency selective amplification. Other applications are described, including one for giving a wideband response for telephonic, and a highly selective response for telegraphic reception, on the same set by a change-over switch.

Marconi's Wireless Telegraph Co., Ltd., and O. E. Keall. Application date August 18th, 1939. No. 533784.

PROJECTION SCREENS

A REFLECTING screen, as distinct from the matt-white or diffusing type, gives a high degree of illumination which, however, extends only over a comparatively narrow arc, of the order of 30 deg. Outside these limits the illumination falls off very rapidly both top

and bottom and at the sides. For a television or cinema screen the top and bottom loss of light is not important, since the audience is usually located within a comparatively narrow vertical arc.

The object of the invention is to provide a screen which will give a greater spread of illumination than usual either at the top and bottom, or at the sides, as may be desired, but not in both directions. This result is secured by making the screen of sheet metal, preferably aluminium, in which a large number of parallel narrow furrows or ridges are formed. The incident light is thereby dispersed in a direction at right-angles to the furrows to a greater extent than it is in the direction parallel to their length. The arrangement is particularly intended for large-sized screens, though the improvement in illumination is noticeable in screens, say, of 3 feet square. It also serves to remove the apparent "veiling" effect of the ordinary type of screen when used for stereoscopic reproduction.

J. L. Stableford. Application date August 31st, 1939. No. 534483.

AUTOMATIC "CONTRAST" CONTROL

THE circuit shown is designed to offset the effect of high audio-frequency interference by utilising such interference to apply automatically a gain-control voltage which increases the low-frequency response of an amplifier feeding the loudspeaker, thereby increasing the intelligibility of the desired signal.

The tone control consists of a condenser C of the Johnson Rabbek type, i.e., one which varies its capacity in response to a change in applied voltage, in series with two resistances R , R_1 and a biasing source B , across the grid circuit of the low-frequency amplifier V feeding the loudspeaker S . The anode of the valve V is coupled to an auxiliary valve V_1 , tuned at K to the interfering frequency. This acts to "isolate" the interference, which is rectified by a diode V_2 , the resulting

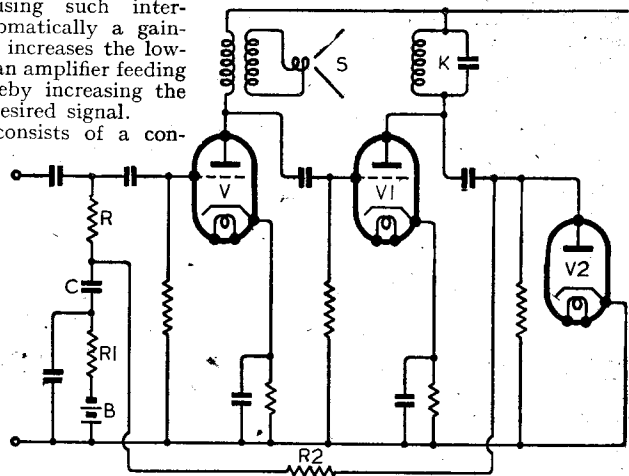

Differential gain-control system

RADIO-ALTIMETERS

THE time taken for a wireless signal to go and return from a reflecting body can be used to measure the distance of that body from the point of observation. The principle has been applied to explore the Heaviside layer, and can also be used as a radio-altimeter for aircraft. Since a wireless signal travels at the speed of light, the problem of measuring the required time interval is not an easy one, particularly for comparatively short

(Continued on page 24a.)

The British abstracts published here are prepared with the permission of the Controller of H.M. Stationery Office, from specifications obtainable at the Patent Office, 25, Southampton Buildings, London, W.C.2, price 1/- each.

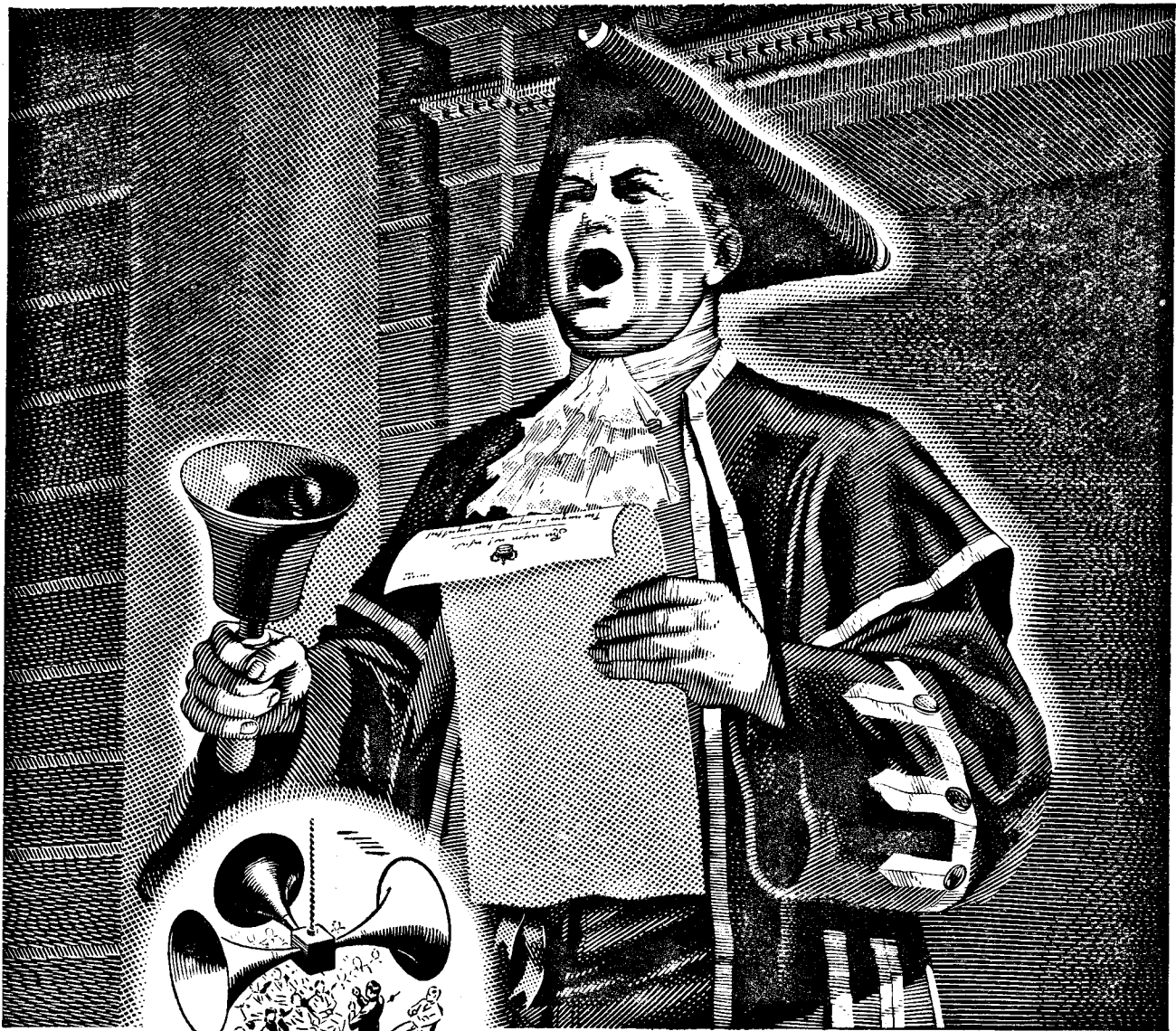

The town crier passes . . .

His equipment was lungs of leather and a clanging bell. His range the market square. He is gone, but his ghost walks to-day in the stands and open spaces of great arenas, in factories and workshops, and in the many other places where the loudspeakers of the sound amplifier enable one voice to speak to thousands. Electrical development has made this possible, for it

has transformed our lives. It has given us brilliant, unlimited light in home and factory; new standards of entertainment in radio; the boon of X-rays in medicine and surgery, and new methods in industry. In all these things the name of PHILIPS is outstanding . . . a symbol of progress and of achievement.

PHILIPS



LAMPS • RADIO • X-RAY & ELECTRO-MEDICAL EQUIPMENT • DISCHARGE LIGHTING
SOUND AMPLIFYING INSTALLATIONS • ARC WELDING EQUIPMENT & ELECTRODES

PHILIPS LAMPS LTD., CENTURY HOUSE, SHAFTESBURY AVENUE, W.C.2

Recent Inventions—

distances. As an alternative, the signal can be frequency-modulated so that the time interval is represented by a corresponding change in frequency, which can then be measured on a frequency meter of the electron-counter type.

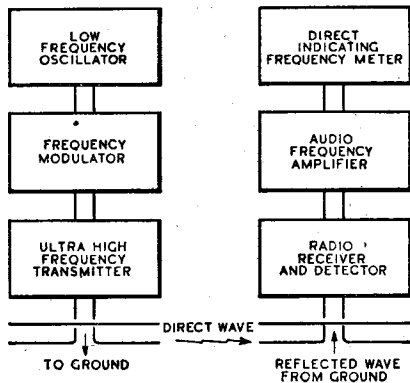

Circuit arrangement for altimeter.

The invention is concerned with the latter type of apparatus. It is pointed out that a "counting" frequency meter indicates the number of times a current reverses, and is therefore only able to register multiples of such reversals, which is not sufficiently accurate for the purpose in view. According to the invention, the difficulty is overcome, at least for heights above 10 or 20 metres, by transmitting a signal which is modulated over a variable instead of a constant bandwidth.

The circuits are shown diagrammatically in the figure, the receiver for the reflected wave being synchronised by a direct link with the transmitter. The required type of signal is obtained by including in the modulator a pair of rotary condensers which are variably driven over a given band width during each cycle of the low-frequency oscillator. This allows the frequency meter to give a continuous instead of an intermittent or "stepped" record of height.

Marconi's Wireless Telegraph Co., Ltd. (assignees of R. C. Sanders). Convention date (U.S.A.), January 28th, 1939. No. 535861.

BOOKS RECEIVED

Thermionic Valves in Modern Radio Receivers, by A. T. Witts.—This book gives an outline of the theory and practice of the application of thermionic valves to modern radio receivers, but it does not confine itself to broadcast-receiver technique. It is intended also to be of use and interest to those engaged in other wireless fields. Reference to out-of-date circuits and to theoretical arrangements not actually employed in present-day receiver design is avoided. In this, the second edition, notes have been added on a large number of subjects, such as push-pull phase-splitters, negative feedback and output tetrodes, thus bringing the book up to date. Pp. 213, Figs. 135, Sir Isaac Pit-

man and Sons, Ltd., Parker Street, London, W.C.2. Price 10s. 6d.

Radio Upkeep and Repairs for Amateurs, by A. T. Witts.—The main idea of this book is to impart sufficient knowledge of the working of wireless sets to enable the average listener to do his own running repairs. It aims at making its readers efficient first-aid men rather than radio doctors, and with this purpose in mind wireless theory has, as far as possible, been kept well in the background. In this fifth edition of the book, first published in 1933, large sections have been revised and even rewritten altogether in order to bring the book into complete alignment with modern practice. Pp. 217, Figs. 136. Sir Isaac Pitman and Sons, Ltd. (address as above). Price 6s. 6d.

Radio Receiver Servicing and Maintenance, by E. J. G. Lewis.—Unlike the book dealt with above, this volume, which concerns itself with a similar subject and is also a new edition of an existent book, is stated to be written mainly for radio dealers, and the wartime recruits to their servicing staffs who desire to equip themselves with the necessary knowledge to enable them to repair customers' sets. The book is entirely practical throughout, and the author advises that actual experiment work be carried out in conjunction with the reading of this book. Pp. 253, Figs. 105. Sir Isaac Pitman and Sons, Ltd. (address as above). Price 8s. 6d.

Roget's Dictionary of Electrical Terms, by S. R. Roget.—This dictionary of electrical terms in which, of course, radio terms are included, steers a middle course between incompleteness and redundancy. In order to reduce the book to reasonable dimensions the subject matter has been kept strictly within the electrical side of the boundary, purely mechanical features of electrical appara-

tus not being included. It is of particular value to the radio engineer since, covering as it does the entire electrical field, it includes many useful terms which strictly radio dictionaries sometimes omit. Pp. 432. Sir Isaac Pitman and Sons, Ltd. (address as above). Price 12s. 6d.

The Wireless Industry

WE have received from Hammans Industries, Ltd., 5, Regent Parade, Brighton Road, Sutton, Surrey, price lists and particulars of laminated sheets with paper and fabric bases, and insulating sleeving of varnished cotton, varnished art silk, wrapped silk (cotton braided), and plastic materials.

Index to Abstracts

FOR several years, our sister journal, *The Wireless Engineer*, has published, as part of the December issue, a subject index to the Abstracts and References section, which is a regular monthly feature of the journal. The inclusion of this index as part of the journal has, however, been discontinued this year, and instead, the index, together with an index to authors, will be published separately early in the New Year. The December issue does, however, include an index to the articles published in the journal throughout 1941. In other respects, the issue is a normal one, including nearly four hundred Abstracts from, and References to, recently published articles in the technical press of the world.

The index to Abstracts and References, which will contain more than 40 pages, should be ordered from the publishers, Dorset House, Stamford Street, London, S.E.1, and will cost 2s. 9d. including postage.

BOOKS ON WIRELESS

issued in conjunction with "The Wireless World"

	Net Price	By Post
"FOUNDATIONS OF WIRELESS," by A. L. M. Sowerby, M.Sc. Third Edition revised by M. G. Scroggie, B.Sc., A.M.I.E.E.	6/-	6/6
"RADIO LABORATORY HANDBOOK," by M. G. Scroggie, B.Sc., A.M.I.E.E. Second Edition Revised and Enlarged ...	10/6	11/1
"WIRELESS SERVICING MANUAL," by W. T. Cocking, A.M.I.E.E. Sixth Edition Revised and Enlarged ...	6/-	6/6
"HANDBOOK OF TECHNICAL INSTRUCTION FOR WIRELESS TELEGRAPHISTS," by H. M. Dowsett, M.I.E.E., F.Inst.P., M.Inst.R.E. and L. E. Q. Walker, A.R.C.S. Seventh Edition in preparation ...	25/-	25/9
"WIRELESS DIRECTION FINDING," by R. Keen, B.Eng. Hons. Sheffield, A.M.I.E.E. Third Edition ...	25/-	25/9
"RADIO DATA CHARTS," by R. T. Beatty, M.A., B.E., D.Sc. Second Edition ...	5/-	5/5
"TELEVISION RECEIVING EQUIPMENT," by W. T. Cocking, A.M.I.E.E.	8/6	9/-
"RADIO INTERFERENCE SUPPRESSION," by Gordon W. Ingram, B.Sc.	5/-	5/4
"LEARNING MORSE," Ninth Edition ...	6d.	7½d.
"RADIO DESIGNER'S HANDBOOK," Edited by F. Langford Smith, B.Sc., B.E.	8/6	9/1
"THE WIRELESS WORLD" GREAT CIRCLE PROJECTION MAP	2/-	2/3
B.V.A. LIST OF EQUIVALENT AND PREFERRED ALTERNATIVE VALVES ...	1/-	1/1

Obtainable from Leading Booksellers and Railway Bookstalls or by post (remittance with order) from

ILIFFE & SONS LTD., Dorset House, Stamford Street, London, S.E.1

CLASSIFIED ADVERTISEMENTS. The charge is 6/- for each paragraph of 2 lines or less, and 3/- for every additional line or part thereof, average 7 words to a line. Each paragraph is charged separately. ADVERTISEMENTS for the February issue are accepted up to First Post on Thursday, January 8th, at the Head Offices of Dorset House, Stamford Street, London, S.E.1, or one day earlier at provincial Offices.

THE PROPRIETORS retain the rights to refuse or withdraw advertisements at their discretion. They are not responsible for clerical or printers' errors; although every care is taken to avoid mistakes. Cheques and postal orders should be made payable to Iliffe & Sons Ltd. and crossed. Notes are legal tender and cannot be traced if lost in transit.

ADVERTISERS may have letters, other than circulars, addressed to numbers at this office. The words Box 000, c/o "WIRELESS WORLD" must be paid for and a further 1/- added for registration and forwarding receipts. DEPOSIT SYSTEM. Full particulars upon application to the Deposit Dept., "Wireless World," Dorset House, Stamford Street, London, S.E.1.

Ode Partridge

No. 12

Good Wishes

Bananas, Onions, Lemons, Figs, Matches, Cream and a nice York Ham, We wish you loads of all these things With pounds of marmalade and jam. Three dozen eggs each week we'd like To see you in your larder cram, That is our wish—but we're afraid You'll have to be content with 'Spam.'

The Whisky too is somewhat scarce, And wines are only got by stealth But nevertheless on Christmas morn We'll find a way to drink your health.

To Friends at Home and Overseas (To end this Ode in serious vein) We send our Greetings most sincere And hope we'll all soon meet again.

N. Partridge

B.Sc., A.M.I.E.E.
Makers of Transformers and Chokes
King's Bldgs., Dean Stanley St.,
LONDON, S.W.1. 'Phone: VICTORIA 5035

NEW RECEIVERS AND AMPLIFIERS

£9/10 Only.—"Wireless World" 2R.F. receiver, with push-pull quality amplifier chassis, 10 valves, including tone control stage, 8 watts triode output, ideal for quality reproduction from radio and gramophone, limited number; reduced price includes all valves.—Bakers Selhurst Radio, 75, Sussex Rd., South Croydon. [19809]

RECEIVERS & AMPLIFIERS, SECOND-HAND, ETC. H.M.V. Power Amplifier, 2 DETI, in push-pull, meter, etc.; £5.—44, St. Mary's Estate, Theford. [19834]

EDDYSTONE S.W. Super Het. Mains Operated Converter, die cast cabinet; £5.—Knowles, 11a, Long Lane, Liverpool, 19. [19825]

Wanted
SECOND-HAND Communication Receiver.—Box 2615, c/o The Wireless World. [19852]

AMERICAN Communication Receiver; also Murphy A50.—2, Cliff Road Gdns., Leeds, 6. [19826]

R.M.E. DR20 Preselector.—Particulars to 55, Derbyshire Rd. Sth., Sale, Manchester. [19828]

R.F. Hallicrafter or Similar.—Offer early or late to 45, Westholme Rd., Manchester, 20. [19840]

WANTED, Hallicrafter Sky Rider, SX24, or similar receiver.—Box 2614, c/o The Wireless World. [19849]

HARTLEY TURNER R.F.41 Feeder Unit, valves optional.—Particulars, price to Fudge, 51, Fairway, Stafford. [19839]

COMPLETE National Standard H.R.O. or Hallcrafters S.X.28, S.X.25, for cash.—Details, 14, Common Rd., Evesham. [19843]

COMMUNICATIONS Receiver (second-hand), Sky Buddy or similar, required for cash.—Box 2611, c/o The Wireless World. [19830]

COMMUNICATION Receiver, H.R.O. National or R.M.E.; reasonable price.—Green, Haydonway House, Coughton, nr. Redditch. [19841]

"WIRELESS WORLD" Deaf Aid Adaptor (28-9-1939) with headphones.—Broadfoot, Penylan, Deganwy Rd., Llandudno, Caerns. [19829]

HIGH-CLASS All-wave Radio Receivers, radiograms, communication sets; good cash prices.—Write A.C.S. Radio, 44, Widmore Rd., Bromley, Kent. [19848]

NEW or used Receivers, Amplifiers, Meters, Converters, Radio & Electrical Accessories. Very high prices paid for really clean apparatus.—'Phone: Gerrard 4447. [19696]

AN American Wireless Communication Set, preferably a Hallicrafter Super Sky Rider or equivalent.—James Logan, Ltd., 124, West Campbell St., Glasgow, C.2. [19864]

LONDON CENTRAL RADIO STORES Will Pay good prices for Receivers, Radiograms, Amplifiers, Dynamos, Converters, Test Equipment, Electric Gramophone Motors, and all Radio and Electrical Accessories.—London Central Radio Stores, 23, Lisie St., London, W.C.2. Gerrard 2969. [19836]

NEW MAINS EQUIPMENT
VORTEXION Mains Transformers, chokes, etc., are supplied to G.P.O., B.B.C., L.P.T.B.; why not you? Imitated, but unequalled.
VORTEXION, Ltd., 257, The Broadway, Wimbeldon, London, S.W.19. 'Phone: Lib. 2814. [19571]

NEW LOUDSPEAKERS
BAKERS Brand New Surplus Speaker Bargains.

EVERY Music Lover Interested in Realistic Reproduction should write for free descriptive leaflet now
£6; usual price £10.—Brand new permanent magnet infinite baffle speaker, complete with beautifully finished cabinet in polished walnut.
£3; usual price £5.—Brand new super quality triple cone speaker, permanent magnet model; exceptional bargain; limited number.
SECURE One of These Exceptional Bargains Now.

BAKERS Triple Cone Conversions Will Immensely Improve Reproduction of Your Present Speaker. ("For a few shillings you have converted a speaker scheduled for the scrap heap into one worth pounds.—W. E. Darby, Grad.I.E.E.") Write for details.
BAKERS SELHURST RADIO, 75, Sussex Rd., Sth. Croydon. [19810]

SECONDHAND LOUDSPEAKERS
HARTLEY TURNER A.C. Speaker, duode De Luxe, complete with rectifying equipments, in 18in. cube box baffle.—Box 2612, c/o The Wireless World. [19833]

EPOCH S.C. Speaker, field 1,000, speech 15 ohms, in mahogany R.G. cab., cost £28; nearest £10.—T. Rice, 37, Plum Tree Way, Scunthorpe. [19863]

PUBLIC ADDRESS
COMPLETE P.A. Installation, suit factory, for hire or sale, new 40-watt amplifier, 10 horn speakers, mike, gram., etc.—11, Hillbury Rd., S.W.17. [19845]

GRAMPHONE EQUIPMENT
AUTOCHANGER Latest A.C. Collozo, mixed records, pieces, £12; Hartley Turner duode speaker, and P.P. output transformer, £8/10; Avo D.C. Minor, £2; all perfect.—Young, Newport House, Stafford. [19861]

ELECTRADIX TEST METERS

ELLIOTT 108, with moving coil meter and rheo, in portable case, 45.-. CELL TESTER, moving coil C.Z. 3-0-3 volts, 45.-. STEEL TEST PANEL, four meters, 7in. dial for full range testing work 5 m.a. to 12 amps. D.C. and A.C.; 5 volts to 300 volts D.C. and A.C., with Rectifier Transformer, two slider rheos, switches and fuses, overall size 27in. x 30in., £15.

VALVES, 6 volt Triodes A.T.40, new, 4/6. Peanut 1 volt triodes Weco, 3/6. Both 4-pin. Neon Lamps, standard type letter, 2/6, miniature, 2/6. Ex-Ray Tubes, 7in., unused, callers only, 15/-.

PHOTO CELLS. Electro Cells, self-generating, Lightometer size, 25/-.

TALKIE CINEPHONE, 35 mm., with head amplifier and meter, £9/10.-. Optical 3-lens unit for 8mm. Talkie, 4 1/2in. long, 4in. dia., 10/6. Ozonizers, 230 volts A.C., for sweet air, 21/-.

RELAYS, No. 6 Telephone, twin bobbin, 6 volt 25 m.a., S.P. change-over, 8/6. Other types in stock.

MAGNET DROP INDICATORS, 2 volts, 2.5 ohm bobbin, pivot armature, hand re-set, can be converted to indicating relay. Useful for signal circuits, bell calls, etc., 2/6.

MORSE INKERS, tape strip dot-dash recorders portable or table type, £7/10.- and £10. Wheatstone strip hand perforator, 15/-, Paper tape for morse inker, green or white, 1/- roll. Brass tape reels in mahog. box for morse tape, 4/6.

MORSE KEYS, Type B.1, 5/-, Type M., 6/6, Type P.F., 9/6, Type IV, 12/6. Special Puller Service Key, few only, 17/6.

BUZZERS, Practice buzzers, 3/6. Brass-cased Buzzer, 4/6. Heavy type, Bakelite, 5/6. Townsend High Note, 10/-.

MICRO MOTORS, A.C. split phase 50 cycles, squirrel cage rotor dog clutch drive to reduction gear, from 2,000 revs. to 58 revs. Voltage 15 to 20, reversible, double shaft, enclosed, laminated, new, 8/-.

HIGH CYCLES ALTERNATORS SINGLE PHASE, Crompton 300 watt, 500 cycle, 50 volts, 6 amps., £8. 270 watt, 500 cycles, 50 volts, 4 amps., £7/15.-. Newton 250 watt, 10 volts, 20 amps., 500 cycles £4/5.-. E.C.C. and Newton, 2,000 watt, 150 volts, 12 amp., 500 cycles, £18/10.-. ALL HIGH SPEED, MOTOR ALTERNATORS, single phase, 1/2 h.p. type "B", input 15 volts D.C., output 50 volts, 1 amp., 500 cycles, £3/10.-. Large Motor Alternator, Newton, 200 volts, 25 amps., 500 cycles, on vertical D.C. Motor, 220 volts, £30.

MEGERS, VERTICAL GALVOS., WHEATSTONE BRIDGES, KEYS, BUZZERS, FIELD TELEPHONES, CABLE, GENERATING SETS AND ENGINES. CRYSTAL SETS need no batteries or mains, Model "B" mahog. case, plug-in coils for broadcast, 15/-, post free.

Postage must be added to all mail orders.
Stamped envelope for all replies.

ELECTRADIX RADIOS

19, BROUGHTON STREET, BATTERSEA, LONDON, S.W.8.

'Phone: Macaulay 2159

ARMSTRONG

EXCELLENT COIL PACKS COVERING 4 WAVE-BANDS STILL AVAILABLE

Shortage of staff have delayed the despatch of some orders, for which we apologise.

Originally designed for use with our export chassis, Model EXP48, which was so favourably reviewed in the October, 1940, issue of *Wireless World*. The Test Report said: "no difficulty was experienced in picking up American stations." This assembly is ideal for constructing a modern receiver using English or Octal valves, for constructing a battery receiver or tuning unit to work with an amplifier. The short-wave performance with the EXP48 coils is extremely high.

Specification. EXP48 coil and switch assembly covering 13-45, 43-160, 200-550, 1,000-2,000 m. Mounted on cadmium plated sub-chassis with 4 position Xaxley type rotary switch. Medium and long wave adjustable paddlers and fixed paddlers on the short wave ranges. Each coil fitted with individual trimmer and the whole assembly wired up. Factory Blue Print giving 7-valve EXP48 circuit and values of components FREE with assembly. Price 35/-. Heavy Steel Chassis for use with above. 12in. x 9in. x 3 1/2in. deep, drilled and cadmium plated. Price 10/6. 465 kc. High "Q" I.F. Transformers. Letz wire wound and fitted with iron cores, in aluminium cans, incorporating trimmers with ceramic insulation. For use with the above. Price 18/6 per pair.

Glass Tuning Scales, 4 wave-band, calibrated in station names and metres. For use with the above. Price 3/6. A complete chassis, incorporating the above components, will be gladly demonstrated at our Showrooms and any technical advice given.

Deliveries should not exceed 14 to 21 days. 'Wireless World' are still available in small quantities.

ARMSTRONG MANUFACTURING CO.
WARTLERS ROAD, HOLLOWAY, LONDON, N.7
'Phone: NORth 3213

HUNT'S MICA CONDENSERS

For Sale
IN 10-GROSS LOTS

All capacities up to .007 mfd. Wire ends and Tag ends.
Price 32/6 per Gross.
.008, .01, .015 mfd.
Price 96/- per Gross.

These well-known British Condensers are brand new.
ALL ORDERS & ENQUIRIES TO

LONDON CENTRAL RADIO STORES
23 Lisie Street, London, W.C.2
Telephone: GERard 2069

L.R.S. PROMPT DELIVERY

There is nothing better than the 'Stuart' Centrifugal Electric SHELTER PUMP

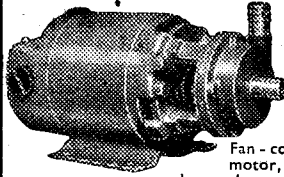

To keep your Shelter or Cellar dry. Ideal for many A.R.P. and general purposes

A sound job built for continuous running. Fan-cooled ball-bearing motor, A.C. or D.C., any voltage. Low current consumption. Connections for rubber hose. All parts non-rusting. Please state exact mains voltage required. These pumps (as supplied to Railway Co.s, County Councils, etc.) may also be used for garden fountains. FOUNTAIN JETS for above, 4- extra. No. 10, 100 gals. per hour Carr. 2/- extra ... £5 2 6

A Useful Accessory

The STUART AUTOMATIC FLOAT SWITCH, dependable and easy to install, is the best method of controlling water-level. Immediately water rises in the sump the Float Switch starts the motor pump. This guarantees no flooding. Price, complete with all fittings, £2.5.0.

A limited number of AVOMINOR D.C. TEST METERS are available from stock. Cash or C.O.D. £2.17.6, plus 6d. postage.

Send 2½d. stamp for illustrated price lists.

LONDON RADIO SUPPLY CO. "WINDEN," ARDINGLY ROAD, BALCOMBE, SUSSEX.



FOR THE RADIO SERVICE MAN, DEALER AND OWNER

The man who enrolls for an I. C. S. Radio Course learns radio thoroughly, completely, practically. When he earns his diploma, he will KNOW radio. We are not content merely to teach the principles of radio, we want to show our students how to apply that training in practical, every-day, radio service work. We train them to be successful!

INTERNATIONAL CORRESPONDENCE SCHOOLS

Dep. 38, International Buildings, Kingsway, London, W.C.2.

Please explain fully about your instruction in the subject marked X.

Complete Radio Engineering Radio Service Engineers

Elementary Radio Television

If you wish to pass a Radio examination, indicate it below.

Inst. of Wireless Technology

P.M.G. Certificate for Wireless Operators

Provisional Certificate in Radio Telephony and Telegraphy for Aircraft

City and Guilds Telecommunications

Name..... Age.....

Address.....

(Use penny stamp on unsealed envelope)

BTH Pezoelectric pickup, boxed, perfect; 30/-, or offer. -1, St. Paul's Ave., Lytham St. Anne. 19850

Wanted

6 Gns, min. record changers, £2/10 for gram units, Adograms-27, Worcester St., Wolverhampton. 19740 PRECISION Built Tracking Gear for Disc-recording. -Benny, Longmynd, Burwood Park, Walton-on-Thames. 19858

CABINETS

FERGUSONIC Cabinet, 1940 model, 107/-; ditto, table model, £1; M.C. speaker, 15/- extra.-4, Lemna Court, Leytonstone, E.11. 19851

WE Regret That, owing to all our employees having joined H.M. Forces, we are unable to accept orders for cabinets except to callers. Limited stock only. We have a large stock of radio components.-H. L. Smith and Co., Ltd., 289, Edgware Rd., London, W.2. Tel.: Pad. 5891. 16683

MORSE EQUIPMENT

FULL Range of Transmitting Keys practice sets and equipment for Morse training.-Webb's Radio, 14, Soho St., London, W.1. Phone: Gerrard 2089. 19553

TEST EQUIPMENT

TEST Oscillator Kits Now Available; limited quantity.-Particulars, s.a. envelope, MacLachlan and Co., Strathyre, Perthshire. 19844

Wanted

BULGIN 465 k.c.s. I.F. Limer.-Bailey, 66, Jackson Ave., Mickleover, Derby. 19855

ALL Types of Test Equipment Required Urgently for work of national importance; signal generators, oscilloscopes, frequency standards, meters, etc.; must be in good condition; write full particulars and prices.-Box W.W., Lovell and Curtis, 30, Bouverie St., E.C.4. 19831

VALVES

Wanted

VALVES Wanted, any quantity from one upwards; also test equipment, service sheets and spares.-J. Bull, 4, Melthorne Drive, Ruislip. 19732

WANTED, T.P. 2620, 402P, X.30, P.E.N.26, V.M.S.4, K.T.63, 2 of each, must be new valves. Pablo Scarf, Maindeed Sq., Newport, Mon. 19743

VALVES of all Types Wanted, including the following: Pen.25, 1.c.6, Vp135, H.L.22, T.P.22, T.P.23, 210 V.P.T., 6.1.7g 80 and 350/120 rectifiers; good prices given.-Box 2610, c/o The Wireless World, 19827

DYNAMOS, MOTORS, ETC.

ALL Types of Rotary Converters, electric motors, battery chargers, petrol-electric generator sets, etc., in stock, new and second-hand.

WARD, 37, White Post Lane, Hackney Wick, E.9. Tel.: Amherst 1393. 10518

COMPONENTS-SECONDHAND, SURPLUS, ETC.

F. H. WILSON (former Manager of Radio Clearance, Ltd.), 52, Chancery Lane, London, W.C.2. Telephone: Holborn 4631.

B.I. Tubular Condensers, N.I., 0.001, 0.002, 0.0003, 0.0005, 0.005, 0.001, 0.05; 5d. each.

T.C.C. Tubular Condensers, N.I., 0.01, 5d. each; 0.1, 7d. each.

T.C.C. Tubular Electrolytics, 25 mfd. 25v., 1/6 each; T.C.C. or B.I. tubular electrolytics, 50 mfd. 12v., 1/6 each; T.C.C. tubular electrolytics, 2 mfd. 350v., 1/6 each; mica condensers, 0.0005, 6d. each.

AIR Spaced 0.0005 Single Gang Variable Condensers, 1/11 each; air spaced 0.0005 two-gang variable condensers, 2/9 each; air spaced 0.0005 three-gang variable condensers, 2/11 each.

PHILLIPS Dual Range Aerial Coils, no reaction, with circuit; 1/6 each.

PHILLIPS I.F. Transformers, 180 kc.; 1/6 each.

YAXLEY Type Switches, 2-pole, 4-way, 4-bank, 4/- each; Yaxley type switch locator units, 6d. each.

DROPPING Resistances, standard replacements for Pye, Lissen and Ever Ready, etc., 535 ohms, tapings of 50 volts; 3/6 each.

CENTRALAB Midget Volume Controls, 2,000 ohms and 100,000 ohms, less switch; 2/9 each.

TRANSFORMERS, mains, 250-0-250v. 80 m.a., 4v. 4 amp., 4v. 1 amp.; 12/6 each.

TRANSFORMERS, mains, 350-0-350v. 80 m.a., 4v. 4 amp., 4v. 2 amp.; 12/6 each.

STRAIGHT Line Dials, 3 wave band; 1/6 each.

VALVE Holders, 5- and 7-pin, chassis type, 4d. each; valve holders, 4-pin, chassis type, 3d. each.

PHILLIPS P.M. Speakers, new, 8in. cone, suitable as extension speaker, 15/- each; loud speaker or telephone cords, 4d. each.

WE Have a Large Assortment of Coils, transformers and valves; we will be pleased to quote if you will let us have details of your requirements.

ALL Orders Must Include Sufficient Postage to Cover.

HOURS: Week-days 9 a.m.-4 p.m., Saturdays 9 a.m.-1 p.m.

F. H. WILSON (former Manager of Radio Clearance, Ltd.), 52, Chancery Lane, London, W.C.2. 19846

COULPHONE RADIO, New Longton, nr. Preston.-Brand new goods only. 8in. Plessey and Goodmans P.M. speakers, with transformer, 22/6; electrolytics, 500v. 8 mfd. 4/-, 8+8 mfd. 7/9, 50 mfd. 50 volt 3/3; Eric 1-watt resistors, all values, 6d. each; Tungsram valves, state requirements. S.A.E. for stock list. 19838

PITMAN'S TECHNICAL

CATHODE RAY OSCILLOGRAPHS.

By J. H. Reyner, B.Sc. (Hons.), A.C.G.I., A.M.I.E.E. M.Inst. R.E. Here is an easily understood guide to the practical application of Cathode Ray Tubes to numerous purposes, including the examination of oscillations or wave forms. Radio men, and particularly those about to enter the services, will find this book a genuine and invaluable guide. It has been given the highest recommendations both for students and teachers. Electrical Times says: "Anyone desiring a clear understanding of the Cathode Ray Oscillograph... cannot do better than purchase this moderately priced book." 8s. 6d. net.

RADIO RECEIVER CIRCUITS HANDBOOK. Containing practical notes on the operation of basic modern circuits.

By E. M. Squire. A useful guide to circuits for members of the radio industry, and radio amateurs. By dealing with the receivers in stages the author has achieved the utmost clarity and conciseness. The text is liberally illustrated with circuit drawings and other diagrams. 4s. 6d. net.

THERMIONIC VALVES IN MODERN RADIO RECEIVERS.

By Alfred T. Witts, A.M.I.E.E. Notes on the use of aligned grids, output, tetrodes, negative feedback and phase splitters for push-pull amplifiers have been added to the text of this new edition, which has been substantially modified generally 10s. 6d. net. Second Edition.

PITMAN'S PARKER STREET, KINGSWAY

Joining the R.A.F.?

ARMY-NAVY-MERCANTILE MARINE OR TAKING UP WORK OF NATIONAL IMPORTANCE in which a thorough knowledge of the Morse Code is essential for becoming a skilled W/T operator? Then investigate the proved Candler method of

MORSE CODE TRAINING

There are courses for beginners and operators.

A Candler trained operator now serving in the R.A.F. says -

"... I should like to thank both yourself and the company for the great start which I obtained through taking your Junior Code Course. The experience which I gained from that, has kept me 'miles in front' of others who relied on obsolete means of learning code."

Fill in the Coupon and learn more about this highly efficient Candler method of Code training in your own home.

JUNIOR Scientific Code Course for beginners. It teaches all the necessary code fundamentals scientifically.

ADVANCED and High-Speed Telegraphing Course for operators who want to increase their w.p.m. speed and improve their technique.

TELEGRAPH Touch-Typewriting Course for W/T operators who want to become expert in using a typewriter for recording messages.

Courses supplied on Cash or Monthly Payment terms.

COUPON

Please send me a Free Copy of Candler "Book of Facts"

NAME.....

ADDRESS.....

Post Coupon in 1d. unsealed envelope to Lond. Manager

CANDLER SYSTEM CO. (55 /.), 121, Kingsway, London, W.2.

Candler System Co., Denver, Colorado, U.S.A.

Another 65-watt SOLON

This 65-watt industrial type SOLON is fitted with an oval tapered bit—a popular shape for all general work. Pencil bit types and heavier models are also available.

Write for
Leaflets.



MADE FOR
USUAL
STANDARD
VOLTAGES

W. T. HENLEY'S TELEGRAPH WORKS CO. LTD.
Engineering Sales Dept., Milton Court,
WESTCOTT, DORKING, SURREY.

Lockwood CABINETS

ACOUSTICALLY DESIGNED

The only Standard Radio
Cabinets with acoustic lining.

Our Model AD500 has been designed for Quality Reproduction. An idea of its efficiency and freedom from "box resonance" can be obtained from the weight which is approximately 3/4 cwt. Although supplies of raw materials are very limited we are still able to manufacture a few of these famous cabinets and also our consoles, from time to time.

For full details of this
and other standard
models send 2d. stamp.

Special designs to your
requirements—FREE
on request.

**LOCKWOOD
& CO.**

65, LOWLANDS RD.,
HARROW, MIDDXX.

'Phone: BYRon 3704

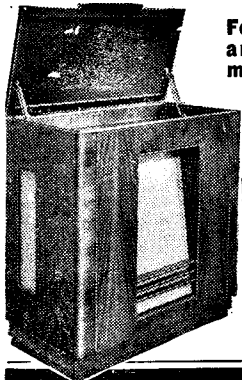

G. A. RYALL, "Arnehurst," Marsh Lane, Taplow, Bucks (late Ryall's Radio, London), offers radio components; post free.

G.E.C. Electrolytic Blocks (as used), inverted type, slightly soiled, 14x14x7x3x3x20x20 mfd., at 450-450-350-450-35-35v., two common leads, 4/9 per block; T.C.C. Midget cardboard, 25 mfd., at 25v., plus 10 mfd. 150v., 1/3 each.

PLESSEY Tuning Coils, in oval cans, oddments only, aerial, B.P., etc., no sets, 4 for 1/3; Ferranti screened coils, pairs, aerial and H.F. transformers with reaction, 2/6 pair, with coil connections.

CELESTION Loud-speakers, energised type, with and without transformers, m.c., mostly 8in. (a few 6in.) fields, 600, 920, 1,200, 2,000, 6,500, 7,000, mostly been damp, out centre, at 12/6 per box five, 17/6 per five, and 22/6 per five, according to condition; please give alternative if best not available; assorted boxes if required; please give full details of requirements, and alternatives; all carriage paid.

CELESTION M.C. Oval Loud-speakers, less transformers, speech coils, 30 ohms, handle 8 watts, fields 750 ohms, 70-100m.a., been damp, out centre, cones intact, pole pieces rusty; 22/6 per box ten, carriage paid.

RESISTANCES, well known make, 1/4-watt, 1 meg., 1/3 dozen, 9/- gross; ditto, 1/2-watt, 800 ohms, 1/3 dozen, 10/- gross; 400 ohms, 1/2-watt, 1/3 dozen, 10/- gross.

CLIX Chassis Valve Holders, 5-pin oblong, 7-pin lemon and round, 4-pin round, all 2/3 dozen; American, 7-pin, chassis, British make, 4/- dozen; insulating tape, 2oz. reels, 1/3 lb.

VOLUME Controls, U.S.A. make, 60,000 ohm, broad base, medium brass slotted spindle, less switch, 1/6 each; Sator midget 1 meg. and 400,000 ohm and 100,000, 1/3 each; British make broad base, 1 meg. and 0.4, at 1/6 each; slightly soiled.

G.E.C. "Taneon" Tuning Indicators, as used in the "AVC Five" neon type, 1/3 each; slow motion (epicyclic) drives, fit 1/4in. shafts, long 1/4in. spindles, well made in brass, with ball bearings, ratio 8-1, 1/3 each.

PAXOLIN Strip, 2 1/4in. wide, as used for group boards, etc., three 12in. lengths for 1/6; group boards, with tags, 12-way, two for 1/3; or drilled, less tags, four for 1/3.

AMERICAN 2v. Battery Valves, sets three, American bases, 1A4VM/HFP, 1B4HFP, 2101 1/2-watt output pentode; 6/6 set three; suit Philco sets.

ERIE Resistors, 1/2-watt type, actual values, as used in many well known sets, 150, 200, 220, 270, 3,300, 6,000, 7,500, 18,000, 25,000, 27,000, 33,000, 150,000, 330,000, 390,000, 1 1/2 meg., 3/- dozen; new goods; Erie resistors, 2 watt type, 800, 1,000, 1,500, 7,500, 8,000, 8,200, 12,000, 30,000, 40,000, 56,000, three for 1/6, new goods; Erie resistors, 3-watt (note, many sizes in 2w. and 3w. are offered with a view to being used in parallel), 150, 300, 350, 390, 400, 680, 700, 1,500, 2,200, 3,300, 4,700, 6,800, 7,000, 12,000, two for 1/6, new goods; T.C.C. 0.1 mfd. tubular non-inductance condensers, 350v. wkg., 5/6 dozen, new goods.

KNOBBS.—Small brown Ultra pattern, 1/3 dozen; large black mottled 2in., three 1/3; Corsor dark brown octagonal, "Radiogram" with arrow, "Wave change," 2/3 dozen; all with brass insets.

CLIX Input Strips, A. and E. P.U. loudspeaker, etc., 2-, 3-, 4-, 5-way, 2/3 dozen; plugs, 1/3 dozen.

LARGE Goldtone H.F. Mains Chokes, heavy duty, two for 1/6, may be slightly soiled; Ferranti wire wound resistors, nickel end caps, 4,000, 6,000, 8,000, 35,000, 4 for 1/3.

CLYDON Type Trimmers on Ceramic Bases, 70 mm., 2/6 dozen; double trimmers on Paxolin, ex G.E.C., not joined, 2/6 dozen; single ditto, 1/6 dozen; ditto, not mounted, 1/2 dozen.

REX Type Switches, 4-bank, 2-pole, 4-way, 5 with shorting plates, 2/6 each; Rex type switch wafers, 3-way, 2-, 3-, 4-pole, 4 for 1/3.

VALVES.—Europa AC/L 4v. 1 amp., makes good detector or L.F. amplifier, 3/3 each; Europa AC/HP 5-pin base, 3/3 each (metallising of the AC/HP may be rather soiled, but all O.K.).

WELL-KNOWN Make Mica Condensers, 0.0028 and 0.003, 1/3 dozen; silver mica Sator, 0.00015, 0.00045, 0.0005, 2/3 dozen; wave traps, ex K.B., iron core, 1/3; switches for band pass H.F. and dial lights, Wearite type, 1/3.

BATTERY Leads, 4-way, with plugs, two for 1/6; cable, 4-way single strand in one cover, 4 yards, 1/3; single connecting wire, white, 18 yards, 1/3.

PLESSEY 2-gang Screened Variable Condensers, with trimmers, straight type, 3/-; 2-gang unscreened, with ceramic insulation, 3/-; less trimmers; 3-gang, screened, with one trimmer only, 3/-; all straight, no superhet types; condenser drives, with 2-band scale, less escutcheon, similar Polar VP, 1/9.

INVERTED Type Mansbridge Condensers, 2x1 mfd., 400v. wkg., 1/3 each; large capacity Mansbridge low-voltage for cathode by-pass, pair in one block, 1/6; small blocks, 0.5x0.5x0.25x0.25, two 1/6.

SPECIAL Note.—We now confine our business to S. Mail Order; prompt attention, in rotation, from a quiet situation; our customers should note that when the present stocks are disposed of there is no likelihood of our being able to offer further surplus goods.—G. A. Ryall, "Arnehurst," Marsh Lane, Taplow, Bucks. [9832]

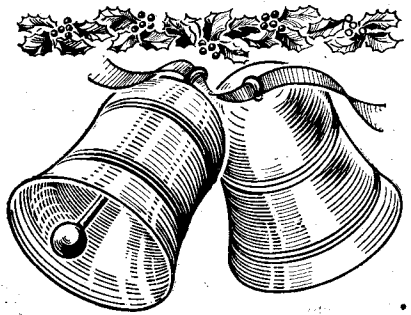

When Christmas Bells Ring Out Again

... their joyous peals will doubtless often be amplified by **R·S EQUIPMENT**. But until that happy day we must turn to sterner tasks. If now your interest is commercial or industrial and your demand is for unusually high standards, we'll gladly send you fullest details of the **R·S** Range or co-operate with you on special needs.

Greetings and
Sincere Good Wishes
to you all

R·S Amplifiers Limited

3-4, Highfield Road, Shepperton, Middlesex.
—Telephone: Walton-on-Thames: 1019—

The RAF wants YOU

Are you keen on radio? The R.A.F. urgently needs you for work of vital importance.

Even if you know nothing about radio, you can study at home in your spare time and qualify as a Radio Engineer. We have successfully trained hundreds of men for the R.A.F. and other vital war-time services. We can train you

Do not miss this wonderful opportunity of qualifying for highly specialised and well-paid service. The work is intensely interesting and you gain experience which can be of tremendous value to you after the war.

Now, more than ever before, the outstanding merits of our tuition are being proved again and again. Students who previously knew nothing about radio have passed the R.A.F. Trade Test with "flying colours."

Waste no time, but post coupon now for free details of our Home-Study Courses for Radio Mechanics, Radio-location, Mathematics, Servicing, Television and Transmission.

★ If you are not liable for service, there are excellent opportunities for you to earn good money in your spare time as a Service Engineer.

T. & C. RADIO COLLEGE 29, Market Place, READING

(Post in unsealed envelope, 1d. stamp)

Please send me free details of your Home-Study Radio Courses.

NAME

ADDRESS

WW

WARD AC/DC ROTARY CONVERTERS

for operating P.A. amplifiers, Radio Receivers, etc.

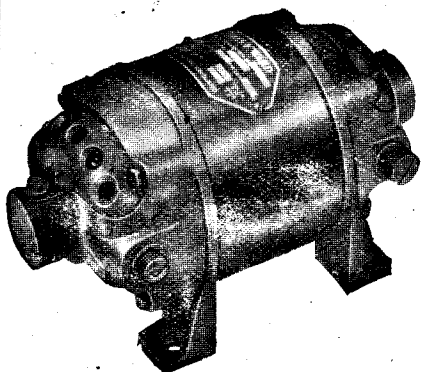

WE ALSO MANUFACTURE

DC/DC ROTARY TRANSFORMERS, SMALL ALTERNATORS, SMALL DC MOTORS, H.T. GENERATORS, MAINS TRANSFORMERS up to 10 k.v.a., PETROL ELECTRIC generator sets up to 50 k.v.a. BATTERY CHARGERS for private and industrial use.

Full details of any of the above upon request. Export enquiries invited.

CHAS. F. WARD,

Office and Works:
37, White Post Lane, HACKNEY WICK, E.9
Telephone: Amherst 1393.

LONDON CENTRAL RADIO STORES Offer Finest Bargains in Radio and Electrical Gear.

PHILIPS Speech Transformers for Pentode Output: 3/6 each.

MORSE Keys. Don't confuse these with inferior junk; it's a super job; 8/6 each.

VALVES are in Short Supply; stock of Mullard T.S.P. 4's and H.V.R. 2's to be cleared at 15/- each; first come, first served

CONDENSERS.—Special offer of metal cased paper condensers, 300v. working, all brand new and unused, 0.2 mfd., 1/9; 1 mfd. x 1 mfd., 1/9; 1 mfd., 1/-; 0.5, 0.25, and 0.1 mfd., 8d.

RESISTORS, 10 watt, 100 ohm vitreous enamelled mains resistors, 1/3 each

EX-BAIRD, wax impregnated cardboard panels, 10 1/2 in. x 6 in., 1/3 doz., short-wave coil, 7.25 metres mounted on ceramic trimmer, 1/- each; a big range of volume controls, 1 ohm, 200 ohm, 600 ohm, 1,000 ohm, all values 2/6 each.

FLEXIBLE Drives, well made, shielded cable drives for remote control, ideal for radiogramophones, approx. 2ft. long; to clear, 4/- each.

MIDGET Volume Controls, 5,000 ohms, 3/6 each.

CONVERTERS, D.C. to A.C., 220v. D.C. input, 220v. A.C. output, 100 watts; £10/10.

ELECTRO-MAGNETIC Counters, resistance 500 ohms, from 1-12,999, size 4 1/2 in. x 2 in. x 1 1/2 in., ex-G.P.O., invaluable for countless purposes, 9/6 each; a smaller type, 11,999, size 4 1/4 in. x 1 1/2 in., 5/6.

VALVE Holders.—Belling-Lee special H.F. 5-pin, chassis mounting in black bakelite; 1/- each, 10/6 doz.

PLESSEY Small Block Type Condensers, two tapings, 0.0005 and 0.1 mfd., 350v. test; 1/- each, 10/6 doz.

VARIABLE Condensers, well made heavy 3-gang superbet condensers, die cast frames in first class condition; 2/6 each.

SMALL Reversible A.C. Motors (as used for motor tuning), 25-30 volts A.C., built-in reduction gear spindle, speed about 60 r.p.m.; 8/6.

ADAK Cutting Heads, heavy duty type, 3.5 ohm coil, a really high-class instrument; 17/6.

YAXLEY Type Switches, 2-way, 1/-; 2 bank 3-way, 2/-; 4-way, 4/-.

SCREENING Shields in Aluminium, 6 1/2 in. x 5 in. x 5 1/4 in., brand new and unused; 2/6 pair.

OUTPUT Transformers, primary 300 ohms D.C., secondary 0.5 ohm D.C., brand new, manufacturer's type, 4/6; also new chokes, 30 henry, 150 ohms, 3/- each.

RESISTANCES, assorted values and makes, Erie, T.C.C., American, etc.; low price of 1/6 doz.

B.I. Condensers, block type oil filled in metal cases with terminals, high quality components, 0.1 mfd., 1,000v. D.C. test, 2/6 each; and 0.25 mfd 1,000v. D.C. test, 2/6 each; also 0.0003 mfd. 400 volt working D.C., 6/- per doz.

RELAYS.—Small relays for operation on 2v. D.C. with 6-way make and break switches, brand new; 5/- each.

TRIMMERS.—Twin trimmers on ceramic base, brand new; to clear, 6d. each, 5/- doz.; also Bakelite Strip containing 5 Postage Stamp Trimmers, 2/6.

WEGO Condensers, tubular type, 0.1 mfd., 5,000v. working; 5/6 each.

COIL Formers, cardboard and paxolin, assorted sizes, useful for experimenters; 1/6 doz.

CONDENSERS, metal cased, non-inductive, 0.5 mfd., 1/6; 1 mfd., 1/9; 1 mfd. x 1 mfd., 2/-; 2 mfd. 2/-.

CHASSIS.—Beautifully finished, highly polished, new cadmium-plated Chassis, Superbly made, 16 1/2 in. x 13 1/2 in. x 4 in. Drilled for 6 valves, transformer, etc. 4/- each. Also heavy gauge metal Chassis, finished battleship grey, 12 in. x 5 1/2 in. x 2 1/2 in., 1/3 each. Also 8 in. x 10 in. x 2 in., 1/3 each. All drilled for valves, etc.

ACCUMULATORS.—Ediswan 2v. 60 amp., brand new, in ebonite cases, size 8 in. x 4 1/4 in. x 2 1/2 in.; callers only; 17/6 each.

SPEAKER Mesh, 10 1/2 in. x 9 1/2 in., 1/6; also chromium escutcheons without dial, 7 1/2 in. x 5 1/4 in., 1/- each.

TUBULAR Wire-end Condensers, brand new, first quality components, 0.0003 mfd., 8d.; 0.005 mfd., 9d.; 0.01 mfd., 10d.; 0.1 mfd., 1/- each.

SEE Also Display Advt. Page 6. Postage must be included. No C.O.D. orders.

LONDON CENTRAL RADIO STORES, 23, Lisle St., London, W.C.2. Phone: Gerrard 2969. 19835

STOCK of Acorn Valves, AT4, AP4, 955 microammeter, and other instruments; 3.5 K.V.A., D.C. to A.C. rotary converter.—Box 2618, c/o The Wireless World. 19860

300 Yds. (150 ohm yd.) Yankee 2-way Line-Cord, best offer over 1/3 yd. 40 Philips new I.F. transformers, best offer above £4. One only Pilot Maestro, c/hand, perfect order, best offer over £5/10. Reconditioned DC/AC converter, perfect, with smoothing unit, in sound-proof case, 250 input, 250, 180 watt output, £10.—Melly, 4, Waterton Ave., Gravesend. 19859

RECTIFIERS.—L.T. metal rectifiers, 6v. 1 amp., 12v. 1 amp., 5/9, post 4d. Instrument type rectifiers for meters, 1 to 10 m.a., 9/6. Kit of parts for charger 2v. 1/2 amp., 12/6, post 7d. L.T. rectifier, 12v. 1 amp., with special transformer, ballast, bulb and holder, charges 2v. to 12v., 24/9, post 8d. Crystal microphones, well-known make, a really good mike, 52/6.—Champion, 42, Howitt Rd., London, N.W.3. 19857

Resolution on Quality

In January most men's thoughts turn quasi-seriously to resolutions. Off-hand, we don't remember if January 1st saw the first Gardner Transformer, but we do know that we made a resolution that it would be as good as the finest materials, coupled with human skill, could achieve. And that resolution is renewed, not each January, but with the making of each Transformer. So when next you are needing really good small Power Transformers up to 4 kva. we'll gladly co-operate with you—the resolutions included, of course.



GARDNER'S RADIO, LIMITED
Somerset • Christchurch • Hants

VALVES

TUNGSRAM, etc.: Types 1F4, 2101, 2A7, 6B7, 6G5, 6U5, 12A5, 10, 19, 33, 35, 36, 37, 39/44, 41, 49, 51, 57, 58, 1H4G, 1F3G, 1J7G, 6B8G, 6AC3G, 6G5G, 6J5G, 6K6G, 6L5G, 6P8G, 6TH8G, 6U3G, 25A0G, 25N0G, 25L6GT, 1H4+, 1H4G, 6M1, 6M4, 6L1, HP210, LD210, LL2, E215, SP220, 600/500, HP2118, MH118, HF2018, V2118, D418, DD13, DD13S, DD4D, DD6, DD4S, DDT13, DD13S, HL13, TH29, TX21, VME4, V028, ME48, SP2D at 1/2 price plus tax.

TRIOTRON, etc.: 24, 27, 35/51, 55, 56, 57, 82035N, ZD2, A214, SD2, DD13S, DDT13S, 80235N, Cossor DDT16, DD/Pen, DVS/Pen, and Osram 6P25 at 1/2 price, free of tax.

USED VALVES (all tested): 01A, 24, 71a, ITL1, AC/HL, PM6D, PM16, MS4, HLLD1320, SP2220, WD30, HP1018, PM12, PM1HF, PM1LF, PM2 at half list price, free of tax.

FIXED CONDENSERS, Mica or wire end: 0.0005 to .004, 6d.; .005 to .05, 9d.; .1 and .25, 1/-; .5, 1/6. Mansbridge, 1 mfd. 6d.; 2 mfd., 1/-.

AERIAL WIRE, 7 strand, insulated copper: 50ft., 1/6; 75ft. 2/-; 100ft., 2/8.

HEADPHONES, 4000 ohm: Sensitive, 12/6 pair; L.F. transformers and chokes, 1/6; variable condensers, .0001 to .00075, 1/-; air dielectric, .0008 and .0005, 1/6; 2-gang, 2/6; 3-gang, 3/6.

RESISTANCES, all values, 1 watt, 6d., 1 watt, 9d.

TERMS:

Cash with order or C.O.D., postage extra.

E. H. ROBINS TRADING CO. LTD.,
32, CITY ROAD, CARDIFF.

FOUNDATIONS of WIRELESS

By A. L. Sowerby, M.Sc., Third Edition revised by M. G. Scroggie, B.Sc., A.M.I.E.E.

Price 6/- net By post 6/6

ILIFFE & SONS LTD.

Dorset House, Stamford Street, London, S.E.1

SOUTHERN RADIO'S Wireless Bargains.

7/6 Assorted components contained in attractive permanent box. 9 assorted valve-holders, 2 volume controls, 12 assorted condensers, 6 resistances, choke wire, plugs, circuits, etc.; 7/6, postage 7d. Ormond loud-speaker units, balanced armature types, small Bakelite, 3/6; unshrouded, 2/6; largest 4-pole type, 6/6. Ace P.O. microphones, ready for use on any receiver, 6/6. Westectors, W.2, 2/6. Telsens radio magazines, complete with 4 circuits, 9d., post free. Wireless crystals, 6d. each, 5/- per dozen. Permanent magnet speakers, 8in., complete with multi-ratio transformer, 20/-. Many other bargains for callers. All goods guaranteed. Please add extra for postage.

SOUTHERN RADIO SUPPLY Co., 46, Lisle St., London, W.C. Gerrard 6553. [9347]

Wanted

WE Buy New or Used Radios, amplifiers, meters, converters, radio and electrical accessories, etc.—Phone: Ger. 4447. [9603]

REPAIRS AND SERVICE

L.T.P. Repair All Mains Transformers and Chokes Promptly.

LONDON TRANSFORMER PRODUCTS, Ltd., Willesden, N.W.10. Wil 6486 (3 lines). [9552]

MAINS, output transformers, chokes, etc., rewound. Davies, 30, Morley Av., Manchester, 14. [9700]

"SERVICE with a Smile."—Repairers of all types of British and American receivers; coil rewinds; American valves, spares, line cords.—F.R.I., Ltd., 22, Howland St., W.1. Museum 5675. [8934]

METROPOLITAN RADIO SERVICE Co. Guarantee Repairs to American and British Receivers. Linecord resistances, condensers, and vol. controls. Trade supplied.—1,021, Finchley Rd., N.W.11. Spe. 3000. [9641]

SPECIALISTS in Repair of Multi-valve Receivers, Quality amplifiers; enquiries for test gear.—Harris, 37, Edgewood Crescent, Hendon 7153. [9856]

TRANSFORMERS, pick-ups, motor rewinds, repairs of all descriptions to the wireless trade.—Marshall, 137, Windmill Lane, Nottingham. [9842]

MAINS Transformer Service, repairs, rewinds, or construction to specification of any type, competitive prices and prompt service.—Sturdy Electric Co., Ltd., Dipton, Newcastle-on-Tyne. [9651]

SITUATIONS VACANT

WIRELESS Technical Instructors Required in Army Units.

EMPLOYMENTS.—Pay 8/9 per day (7 days a week); clothing, rations and accommodation, or if this cannot be provided allowances at authorised rates; if married and otherwise eligible, family allowance payable in respect of wife and children, subject to allotment from pay.

CANDIDATES Should Preferably be under 35 and over 24, and

(A) Hold one of the following qualifications:—

- Graduateship of the Institution of Electrical Engineers.
- Final (Grade III) Certificate of City and Guilds of London Institute Examination in Radio Communication.
- Higher National Certificate in Electrical Engineering.
- Certificate of City and Guilds of London Institute in Radio service work.

Or

(B) Be able to pass on examination on the following syllabus:—

- Simple algebra, including quadratic equations; simple trigonometrical ratios and identities; vectors.
- Properties of electrical currents; heating of conductors; magnetic fields; unit of current; Ohm's Law; resistance in series and parallel; potentiometers.
- Magnetic effect of current fields due to parallel wires; field due to a solenoid; electro-magnets. Meters.
- Induction; effect of rotating a coil in a magnetic field.
- Mutual and self induction and inductance; effect of inductance on growth and delay of current.
- Capacity; charging storage and discharge of condensers; through resistance and inductance.
- Alternating currents; vector diagrams; effect of resistance variation; effects of L and C in A.C. circuit; phase difference of currents; resonance in a series circuit; parallel circuit of L and C; Q factor.
- Elementary knowledge of valves; simple theory of amplifiers, oscillators and detectors; general principles of radio practice

SUITABLE Candidates will be interviewed at Local Centres, and, if successful, will be enlisted and appointed Acting Sergeant Tradesman. For those who are on the Schedule of Reserved Occupations, special arrangements will be made to enable them to be enlisted. In the event of any applicant found to be reserved under Schedule of Reserved Occupations special application will be made for relaxation of the Schedule. No guarantee can be given that this application will be successful.

APPLICATION Forms may be Obtained by Postcard from the Under-Secretary of State, The War Office (A.G.6c), Whitehall, S.W.1. [9520]

WANTED in London, experienced shorthand typist, familiar with wireless technical terms and not liable to call-up.—Send full particulars to Box 2617, c/o The Wireless World. [9584]

GALPINS

ELECTRICAL STORES

21, WILLIAM ST., SLOUGH, BUCKS.

Phone: SLOUGH 20855 TERMS: Cash with Order

MOTOR-DRIVEN ALTERNATOR, direct coupled, motor, 110 or 220 v. D.C. input, complete with starter; alternator output 220 volts, 50 cycle, single phase, 176 watts, fitted governor; mounted on teak beams and fitted handles for carrying, condition as new, wear nil, size overall 40in. by 9in. by 11in. Price **£16**, carriage forward.

DYNAMO, 110 volts, 60 amps, shunt wound, interpole, ball bearing, speed 1,750 r.p.m. continuous rating. Price **£15**, carriage forward.

EX G.P.O. MORSE INKER AND TAPE RECORDER, complete with actuating relay and tape reel, mounted on mahogany base, clockwork model, in good clean condition and perfect working order. Price **£15**, carriage paid.

CAR DYNAMOS, small round type, output 6 volts at 10 amps, in perfect working order. Price **17/6**, carr. paid.

SHEET EBONITE, size 12in. by 11in. by 1/32in., best quality. Price **4/-** per doz., post free.

ELECTRIC LIGHT CHECK METERS, well-known makers, first-class condition, electrically guaranteed, for A.C. Mains 200/250 volts 50 cy. 1 phase 5 amp. load, **10/-** each; 10 amp. load, **12/6**; carriage 1/-.

D.C. ELECTRIC LIGHT CHECK METERS, 200/250 volts, 5 and 10 amps, in new condition and electrically perfect; **7/6**, post 1/-.

AUTO. CHARGING CUT-OUT AND VOLTAGE REGULATOR, ex-R.A.F., suit any dynamo up to 20v. at 15 amps., fully adjustable, with wiring instructions, complete in metal case, **3/6**, post 9d.

X-RAY TRANSFORMER, 110/220 v. A.C. input; output 45,000 volts at 7 milliamperes, as new, small portable type. **£12/10/-**, carriage forward.

X-RAY TRANSFORMER, 110/220 v. A.C. input; output 90,000 volts at 60 milliamperes, latest type safety model, complete with high tension leads. Price **£25**, carriage forward.

ROTARY CONVERTOR, vertical type, 220 v. D.C. input; output 150 volts at 150 watts, complete with transformer for 110 to 240 volts, complete with starter, stand good overload. Price **£6/10/-**, carriage forward.

MOVING COIL MOVEMENTS, full-scale deflection 10 milliamperes on a 4in. scale, in first-class condition and perfect working order. **15/-** each, post free.

LARGE TRANSFORMER, approx. 10 kW, 320 volts to 120 volts, would make good arc welder, condition as new. Price **£10**, carriage forward.

REPULSION INDUCTION MOTOR, maker "Century," 1 h.p., speed 940 r.p.m., complete with starter, condition as new. Price **£18**, carriage forward.

ELECTROSTATIC VOLTMETER, 8in. dia. reading 0-6,000 volts, in new condition. **£7/10/-**.

AUTO TRANSFORMER, 1,500 watts, tappings 0-110-200-220 and 240 volts for step-up or step-down. Price **£5**, carriage paid.

CRYPTO A.C. MOTOR, 1/2 h.p., speed 3,000 r.p.m., note short shaft, in perfect working order. Price **45/-**, carriage paid.

110 V. BULBS 150 C.P., Ediswan screw fitting, half watt gas-filled, 2/6 each, post free, or 22/6 per doz., post free.

FRACTIONAL H.P. D.C. MOTORS, for 110 volt and 220 volt D.C. mains, only from 1/20th to 1/2 h.p., state size and voltage required. Price **10/-** each, carriage 1/-.

TELEPHONE MAGNETS, or hand calling generators, 3 and 4 magnet type, unboxed, in good working order. Price **7/6**, post free.

HIGH-FREQUENCY TRANSFORMERS, 100 v. A.C. input; output 5,000 volts, 500 watts, 500 cycles. **50/-** each, carriage forward.

LARGE TRANSFORMERS for rewinding, rating unknown, size 1 kW. auto. Price **17/6**, carriage paid.

LARGE TRANSFORMERS for rewinding, size 2 kW. auto., rating unknown. Price **30/-**, carriage forward.

WOUND RESISTANCES, mounted on enamelled iron, overall size 12in. by 1 1/2in., resistance 6 ohms, wound with 18 gauge chrome nickel wire, new and unused. Price 2/6 each, post free, or 25/- per doz.

HIGH-VOLTAGE CONDENSERS, size 4in. by 4in. by 10in. 1 mf. 4,000 v. working. Price **15/-**, carriage paid.

LARGE A.C. MOTOR for rewinding, size 2 to 3 h.p., induction type, in good mechanical condition, ring oiler bearings. Price **50/-**, carriage forward.

LARGE HOT-AIR ENGINE, 5 1/2in. dia. piston, in good mechanical condition. Price **£4**, carriage forward.

TECHNICAL Radio Journalist, conversant with typography and used to dealing with printers and engravers, wanted for writing, sub-editing and preparing technical matter.—Applicants, who should not be liable for military service, must apply, giving age and experience, to Box 2616, c/o The Wireless World. [9853]

SITUATIONS WANTED

EXECUTIVE Engineer, 18 years' experience radio research, development, production, desires appointment where up-to-date knowledge, organising ability and commercial administration can have full scope; full knowledge present Government requirements.—Box 2619, c/o The Wireless World. [9862]

TECHNICAL TRAINING

GREAT Possibilities Exist for Technically Qualified Engineers, key men in wartime and afterwards. Through the home-study courses of The T.I.G.B. take a recognised engineering qualification such as A.M.I.Mech.E., A. M. I. E. E., A. F. R. Ae. S., A.M.I.Chem.E. C. and G., etc., in which examinations the T.I.G.B. students have gained 25 FIRST PLACES and Hundreds of Passes. Write to-day for "The Engineer's Guide to Success"—Free—containing the world's widest choice of engineering courses covering all branches, including Aeronautical, Mechanical, Electrical, Wireless, Chemical, etc.

THE TECHNOLOGICAL INSTITUTE OF GREAT BRITAIN, 82, Temple Bar House, London, E.C.4. [9335]

TUITION

RADIO Training.—P.M.G. exams. and I.E.E. Diploma, prospectus free.—Technical College, Hull. [0611]

MORSE Code Training in Your Own Home; "Book of Facts" free.—Candler System Co. (W.O.), 121, Kingsway, London, W.C.2. [9744]

PRACTICAL Radio Postal Courses, coaching for I.P.R.E., R.A.F., A.I.D. exams.; booklet free.—Secretary, I.P.R.E. Bush House, Walton Avenue, Henley-on-Thames. [9547]

RADIO Engineering, Television and Wireless Telegraphy, comprehensive postal courses of instruction.—Apply British School of Telegraphy, Ltd., 179, Clapham Rd., London, S.W.9 (Estd. 1906). Also instruction at school in wireless for H.M. Merchant Navy and R.A.F. [9249]

BUSINESSES FOR SALE OR WANTED

THE Wireless and Electrical Trader "is an essential part of the equipment of every Wireless Trader, its pages reflect the very latest turn of trade events, and it is read by all the leading dealers and manufacturers, for particulars of businesses offered or wanted. By subscription, to the trade only, 17/6 per annum, post free.—Send your trade card for specimen copy to "Dorset House, Stamford St., London, S.E.1. [0614]

PATENT NOTICE

THE Owner of British Patent No. 380,876 relating to "Improvements in or relating to Signalling Systems" is desirous of entering into negotiations with one or more firms in Great Britain for the purpose of exploiting the invention either by sale of the Patent Rights or by the grant of Licences on reasonable terms. Interested parties who desire further particulars should apply to Albert L. Mond and Thiemann, 14 to 18, Holborn, London, E.C.1. [9824]

MISCELLANEOUS

WANTED, coil winding machine (small) for winding small honeycomb coils.—Reply Box 2613, c/o The Wireless World. [9837]

BOOKS, INSTRUCTIONS, ETC.

WEBB'S Radio Map of the World Locates Any Station Heard. Size 40x30in. 4/6, post 6d. On linen, 10/6, post 6d. Webb's Radio Globe, 12in. model, Radio prefixes, zones, etc., 27/6.—Webb's Radio, 14, Soho St., London, W.1. Phone: Gerrard 2089. [9554]

EVERY Radio Dealer Who is Not a Regular Reader of "The Wireless and Electrical Trader" should send his trade card at once for a specimen copy and full details of the "Trader" Services. "The Wireless and Electrical Trader" has the widest influence, and is read by all the leading manufacturers and traders. Trade only, 17/6 per annum, post free. Published at Dorset House, Stamford St., London, S.E.1. [0615]

"COSMOCORD"
CRYSTAL PICK-UP

LICENSED BY BRUSH CRYSTAL CO., LTD., under Brit. Pat. Nos. 366,252 and J 454,395



Retail Price **27/6** Plus Tax

Trade only supplied.

SOLE SELLING AGENTS:
SALE, TILNEY & Co., Ltd.,
3, LLOYD'S AVENUE, LONDON, E.C.3
Phone: ROYAL 4811.

RELAYS

for A.C. and D.C.

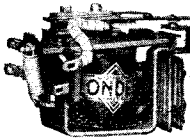

SILENT & RELIABLE
2 VA coil consumption, from 2-600 volts, tested to 2,000 volts. Unmounted and in cast iron casing. Also Time Lag Relays. High Sensitive Relays, complete control plants.

Midget Relay type ML (for D.C. only) Apply for leaflet SPN/WW

LONDEX LTD.

Electrical Remote Control Engineers and Manufacturers

Anerley Works, 207 Anerley Road, London, S.E.20
Tele.: SYDENHAM (258/6259).



ENGINEERING OPPORTUNITIES

This unique Handbook shows the easy way to secure A. M. I. C. E., A. M. I. Mech. E., A. M. I. E. E., A. M. I. Brit. R. E., and similar qualifications. **WE GUARANTEE—“NO PASS—NO FEE.”** Details are given of over 150 Diploma Courses in all branches of Civil, Mech., Elec., Motor, Aero, Radio and Production Engineering, Draughtsmanship, Tracing, Inspection, Government Employment, BUILDING (great scope), MATRIC., R.A.F. MATHS., etc. Write for this enlightening Handbook to-day, FREE and post free. Men with Radio knowledge can obtain attractive posts in the Services. **BRITISH INSTITUTE OF ENGINEERING TECHNOLOGY, 387 Shaftesbury House, 17, 18, 19 Stratford Place, London, W.1**

MICROPHONES

WE CAN NOW ACCEPT PRIORITY CONTRACTS FOR MOVING COIL MICROPHONES

LUSTRAPHONE CO.

Manufacturers of Sound Equipment,

120, STATION ROAD, HARROW

Phone: Harrow 2772 (Private Exchange).

TRIX SOUND EQUIPMENT

RELIABLE AMPLIFICATION
The TRIX ELECTRICAL COMPANY LTD.
65, Bolsover St. London, W.1. Euston 5471

ARDUX WELDS PLASTICS

AERO RESEARCH LIMITED
PIONEERS OF SYNTHETIC ADHESIVES
DUXFORD CAMBRIDGE TELEPHONE SAWSTON 109

This space reserved for

W. BRYAN SAVAGE LTD.

CLASSIFIED ADVERTISEMENTS intended for the FEBRUARY ISSUE can be accepted up to Thursday, January 8th.

for AMPLIFIERS, TRANSFORMERS AND ALL P.A. EQUIPMENT

ACOUSTICAL

MANUFACTURING COMPANY
ERMINE STREET, HUNTINGDON. Telephone: HUNTINGDON 361

Victory Peace Liberty

VOIGT PATENTS LTD.

HOPE TO RESUME SPEEDY DELIVERIES.

BE WISE AND PATIENT

A HANDBY META DEAR

THE COURTS · SILVERDALE · LONDON · S.E.26 Telephone: SYDenham 6666

MELTON METALLURGICAL LABORATORIES LTD

LIQUID SILVER

for metallising CERAMIC, MICA, QUARTZ or GLASS.

Low melting-point SOLDER from 70°C. or to specification. Non-corrosive Liquid FLUX for all electrical or Radio purposes.

Pre-War deliveries. Overseas enquiries invited.

IPSWICH RD., TRADING ESTATE, SLOUGH, BUCKS. Phone: Slough 20992

INVENTORS

We continually seek new inventions and products in all branches of industry for development and production by the manufacturing Companies of the Simmonds Group throughout the world.

SIMMONDS DEVELOPMENT CORPORATION LTD.
BUSH HOUSE, W.G.2.

Printed in England for the Publishers, LIFFE AND SONS LTD., Dorset House, Stamford Street, London, S.E.1, by THE CORNWALL PRESS LTD., Paris Garden, Stamford Street, London, S.E.1. "The Wireless World" can be obtained abroad from the following: AUSTRALIA AND NEW ZEALAND: Gordon & Gotch, Ltd. INDIA: A. H. Wheeler & Co. CANADA: Imperial News Co.; Gordon & Gotch, Ltd. SOUTH AFRICA: Central News Agency, Ltd.; Wm. Dawson & Sons (S.A.), Ltd. UNITED STATES: The International News Co.

DENCO

CLACTON-ON-SEA
ESSEX Phone 151

PRODUCTS FOR WORK OF NATIONAL IMPORTANCE

RADIO COMMUNICATION EQUIPMENT: Receivers, Transmitters, Tranceivers, Frequency Sub-Standards.

POLYSTYRENE. THE U.H.F. INSULATOR: Sheet, Rod, Tube and Various Coil Formers.

DENFIX polystyrene low-loss cement and varnish.

COMPONENTS (employing polystyrene insulation): S.W. Variable Condensers, Coils, R.F. Chokes, Stand-off Insulators, I.F. Transformers, Feeder Spacers, etc.

Special Components or Combination Components.

WHARFEDALE

REPLACEMENT TRANSFORMERS

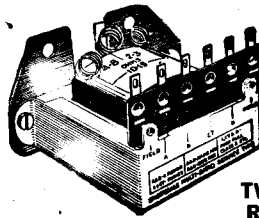

MULTI-RATIO SERVICE TYPE
High Inductance

TWELVE RATIOS PRICE 7/- (list)

With Tapped Secondary gives 4 Primary and 3 Secondary Ratios: matches Output Valves to Speakers of 2/3 ohms, 4/8 ohms or 10/15 ohms. Inductance 65 Henrys zero D.C. Max. D.C. 50 m/amps.

Other Replacement Requirements will be fully covered by the undermentioned types :-

INTERVALVE			OUTPUT		
Model	Ratio	List Price	Model	4 Ratios	List Price
Permalloy L.F.	1 to 3	7/6	Type P.	4 Ratios	5/9
Permalloy Q.P.P.	1 to 5	7/6	M.R. Service	12 "	7/-
Service L.F.	1 to 3	7/6	Standard	3 "	9/6
Class B Driver	2 to 1	7/6	Universal	6 "	11/-
Service Q.P.P.	1 to 5	7/6	De Luxe	6 "	17/6

WHARFEDALE WIRELESS WORKS

SOLE PROPRIETOR: D. E. BRIGGS

HUTCHINSON LANE • BRIGHOUSE • YORKS
PHONE: BRIGHOUSE 50 GRAMS: "WHARFEDALE"

ROLA

LOUD SPEAKERS

THE WORLD'S FINEST REPRODUCERS

TRANSFORMER LAMINATIONS

Core Widths 3/4" to 1 1/2" (E's and I's.)

EIGHT STOCK SIZES

A Comprehensive Bulletin together with details of Associated Covers and Clamps with design data will be sent to manufacturers on request.

BRITISH ROLA LIMITED

MINERVA ROAD · PARK ROYAL · N.W.10 · WILLODEN 4322

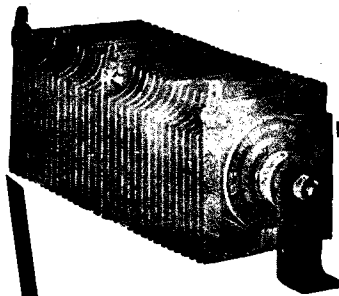

STRENGTH
RELIABILITY & EFFICIENCY

The great mechanical strength, outstanding reliability and high efficiency of the Westinghouse Metal Rectifier makes it indispensable to all discriminating constructors. It is not easily broken . . . it lasts for years and years.

There is a unit to suit every possible wireless need. "The All Metal Way" describes them all, and contains many circuits. The attached coupon will bring you a copy.

Westinghouse

Westinghouse Brake & Signal Co. Ltd., Pew Hill House, Chippenham, Wilts
I enclose 3d. in stamps. Please send me "The All Metal Way."

Name.....
Address.....

W.W. 1.42

F R E Q U E N T I T E

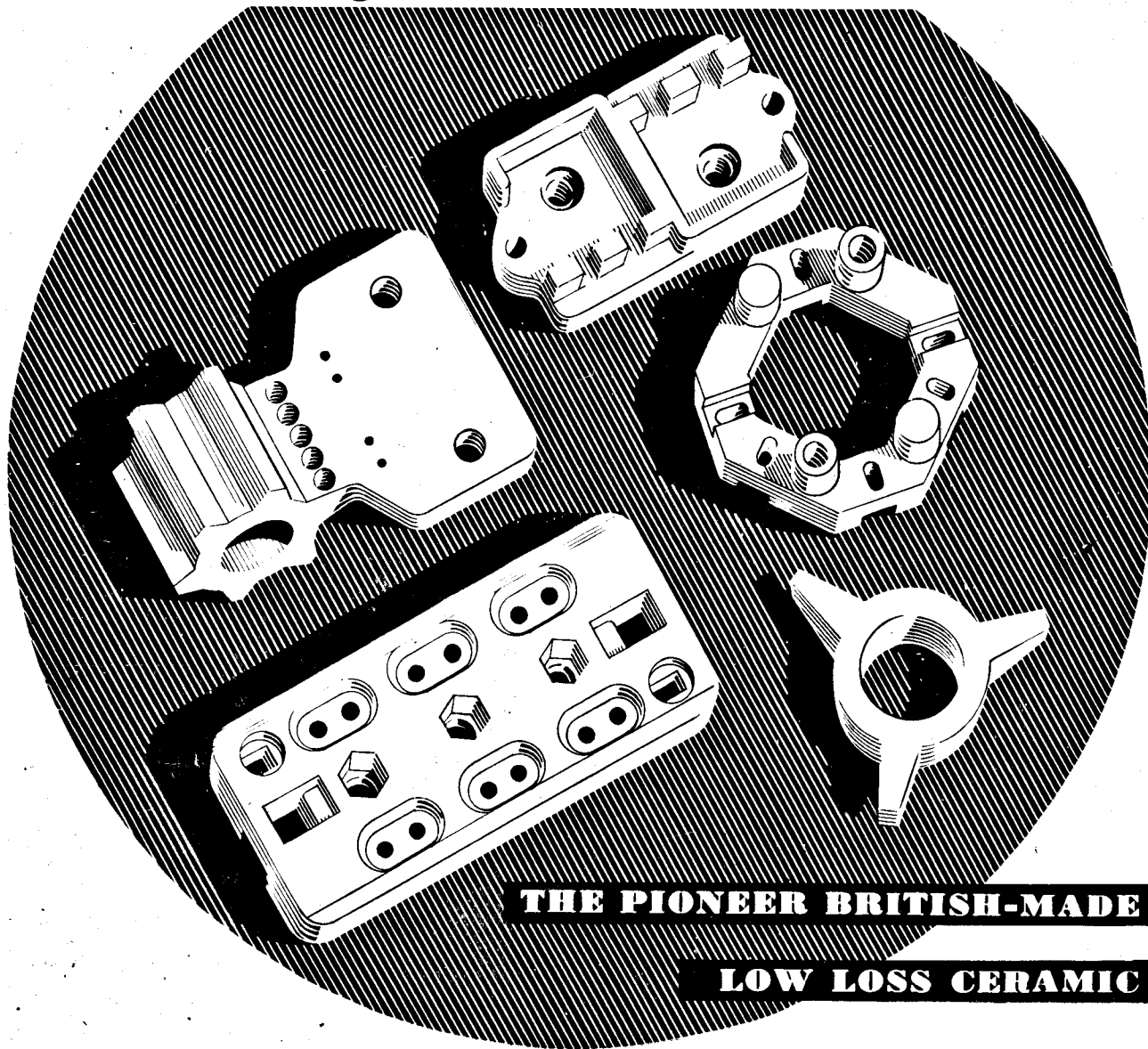

THE demand for Frequentite, which possesses outstanding properties of Low Loss and High Mechanical Strength, continues to increase rapidly—*and to be met.* Production capacity has been stepped up over a period of years by extensions to plant, the

employment of specialised new equipment, and progressive improvements in manufacturing technique. Bulk supplies of the most intricate designs can be delivered promptly, and all manufacturers are invited to write for Catalogue No. S.P.10.

STEATITE & PORCELAIN PRODUCTS LTD.

Head Office : STOURPORT-ON-SEVERN, WORCS.
 Telephone : Stourport 111. Telegrams : Steatoin, Stourport.